

## S4.4 CarProg Motorola HC11 Programmer manual

For Motorola MPU MC68HC11 series programming use A10 cable.

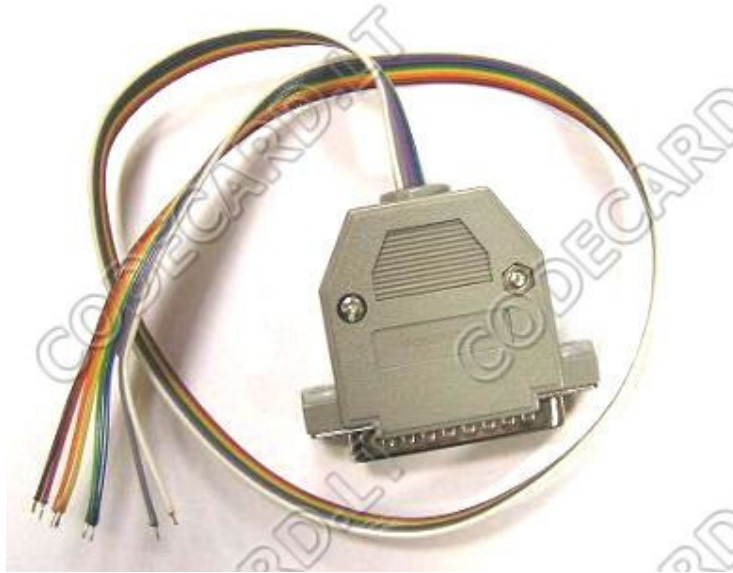

**You can recognize Motorola (Freescale) MPU by maskset:**



This MPU maskset is 4C11W.

- First digit "4" is mask series number, in practice can be 0, 1, 2, 3, 4 or 5, but for programming is not important.

# CARPROG

- Second 4 symbols is always letter + digit + digit + letter: this is processor maskset or encrypted processor type. All processor marking can be custom made, like "FORD S2234234" or SC2323454 but always you can find maskset on Motorola or Freescale processors.

**Before programming always select right processor type according maskset.**



# CARPROG

## How to connect CarProg programmer:

For HC11 programming use A10 cable 7 color wires:

- YELLOW** – communication signal from MPU;
- GREEN** – communication signal to MPU;
- BLUE** – Reset signal to MPU;
- ORANGE** – MODB signal to MPU, low level;
- BROWN** – GND (ground);
- RED** – switched +5V;
- VIOLET** - switched +12V;

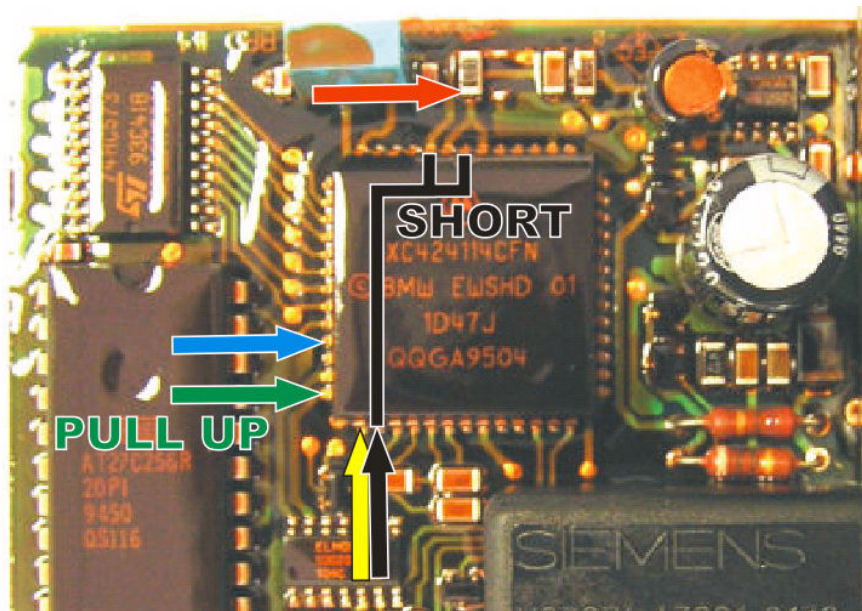
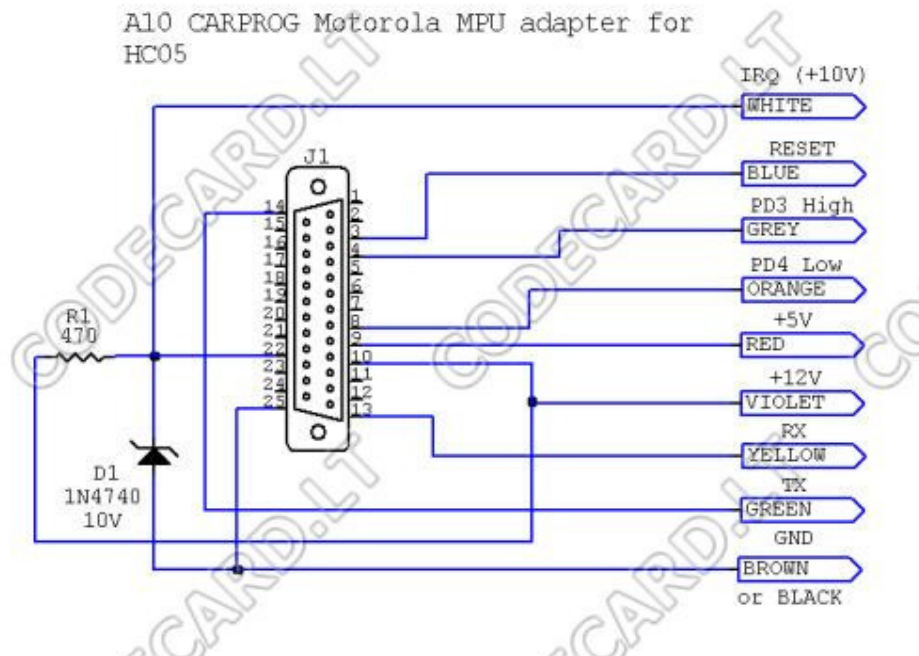

**Troubleshooting:**

CarProg ERROR messages:

- **Communication error** - no communication between CarProg and Motorola processor - check MPU type, try to select quartz frequency manually.





**MC68HC11 processor security bit** in many case is ON (especially in car radios), and when you try to read MPU internal memory first time, MPU will clear security bit itself. But if security bit was ON, after first try to read HC11, processor internal EEPROM will by lost.

**Don't try to read HC11 MPU if you not sure that you have file for EEPROM recovery.**

To understand better onboard MPU programming problems, you can use table with right programming signals and voltages, described in table.

**If you can't read or write MPU with CarProg, check:**

- did you was select right MPU type;
- did quartz resonator Q is the same in circuit board and in CarProg options;
- did all programming signals have right form and voltage;

	Yellow TXD From MPU	Green RXD To MPU	Orange LOW MODB	Blue RESET
All HC11 MPU	<b>Impulse 3.3-5V</b> 	<b>Impulse 3.3-5V</b> 	<b>0 V</b> 	

If all conditions are OK, ask [support@codecard.it](mailto:support@codecard.it)

## 1. MC68HC11A0, MC68HC11A1, MC68HC11A8

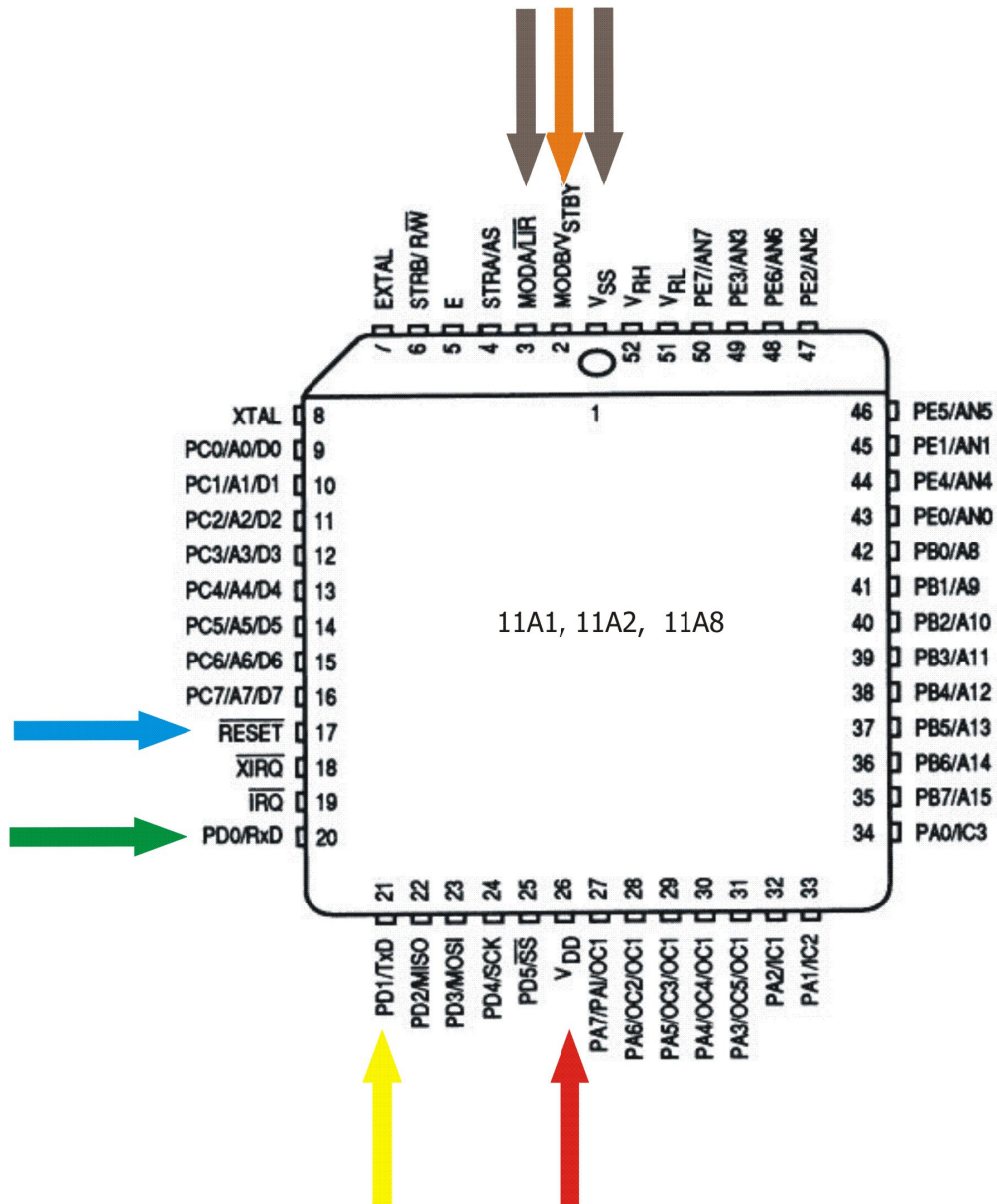

# CARPROG

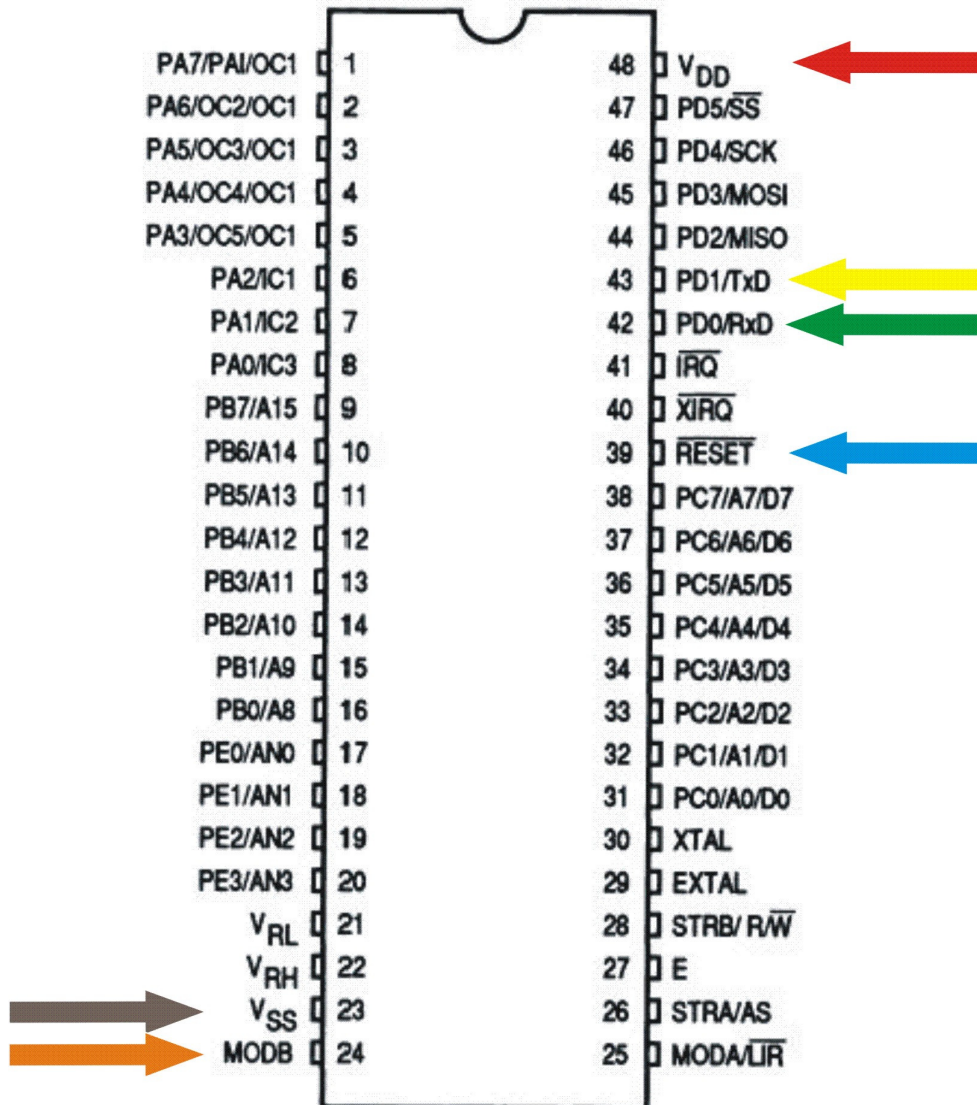

**MPU**  
MC68HC11A0  
MC68HC11A1

**Mask Set**  
B84T  
C11W  
A38P  
A49N  
B46E  
B95T  
B96D

**MPU**  
MC68HC11A8

**Mask Set**  
B65H

# CARPROG

## 2. MC68HC11E9, MC68HC711E9, MC68HC11E20

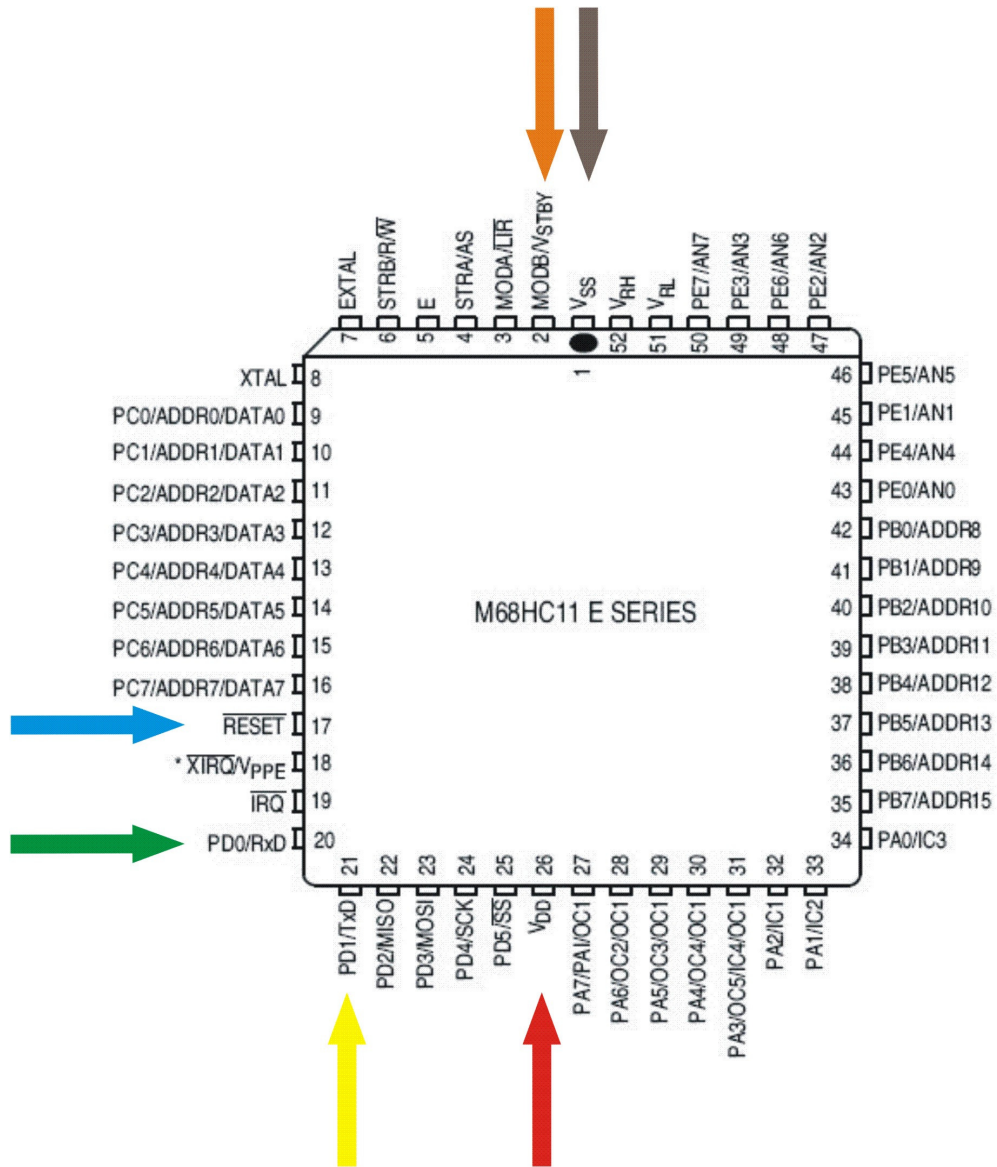

MPU	Mask Set
MC68HC11E1	C91F B60R
MC68HC11E9	C83W C96K D35E D82R F96J C96N
MC68HC11E20	E22B E82K H89E K82H

# CARPROG

MC68HC711E9	E50W
	H50W
	K81H
MC68HC711E20	D43R
	G59F
	H19S

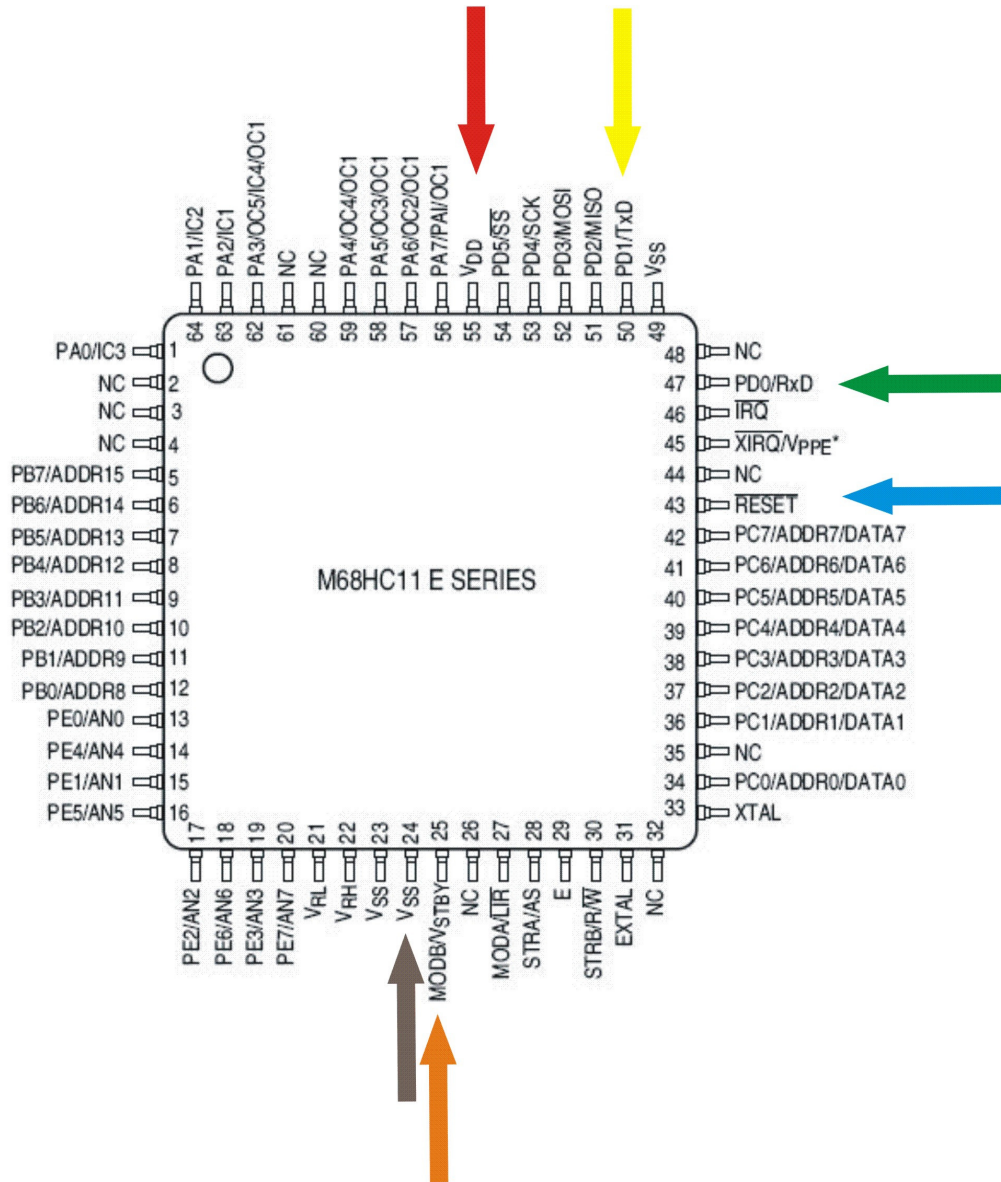



# CARPROG

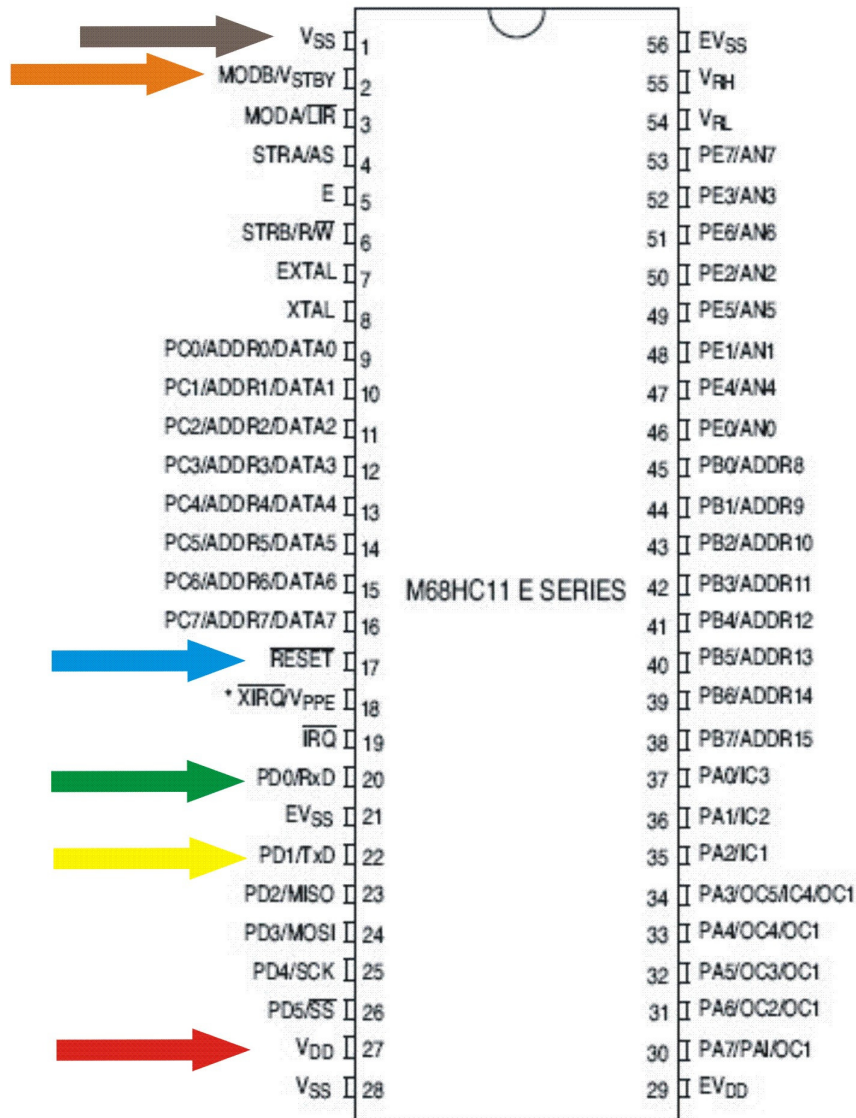

**3. MC68HC11EA9, MC68HC711EA9**

**MPU**  
MC68HC11EA9

**Mask Set**  
D47J  
D46J

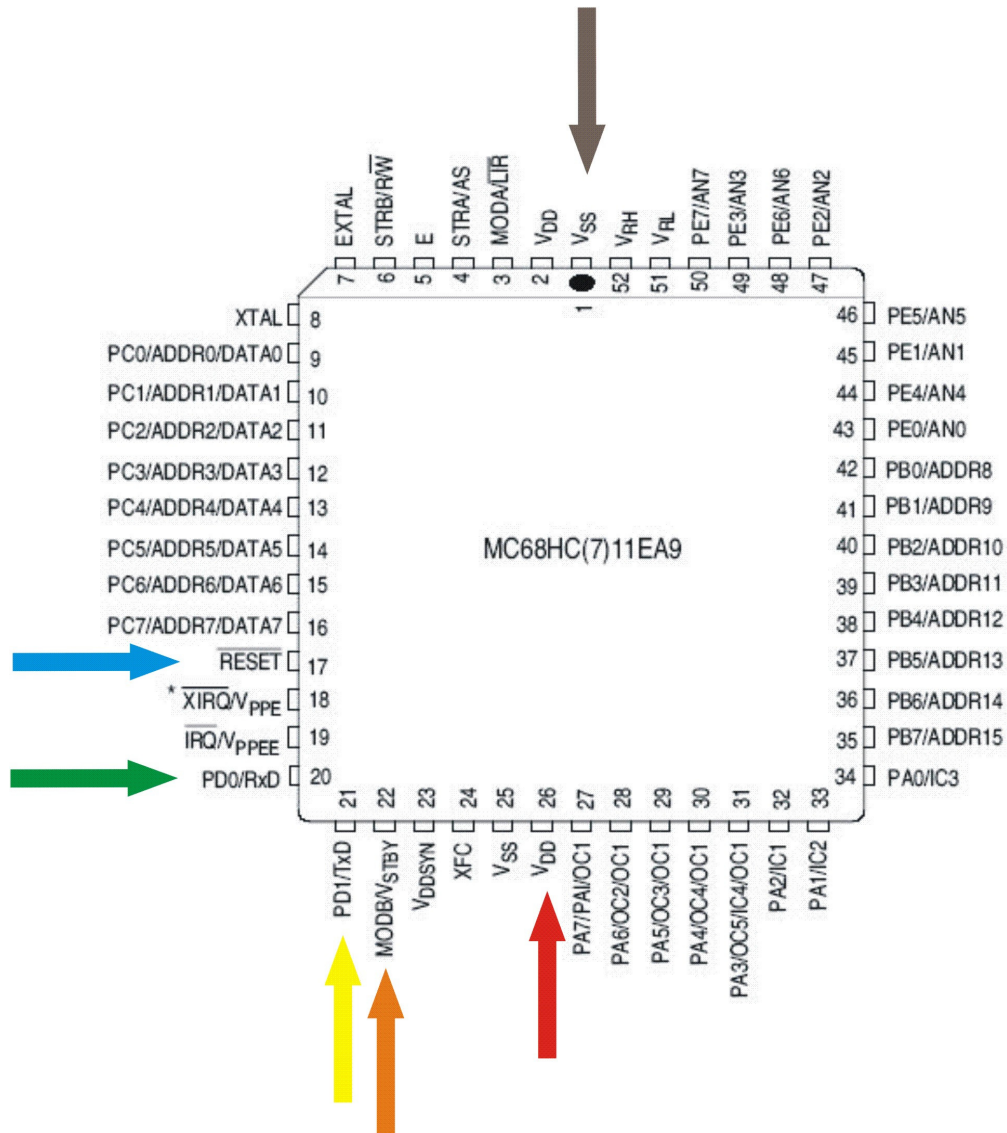

# CARPROG

## 4. MC68HC11F1, MC68HC711F1

<b>MPU</b>	<b>Mask Set</b>
MC68HC11A8	B77M
	C15J
	C94R
	E61H
	E87J
	F37E

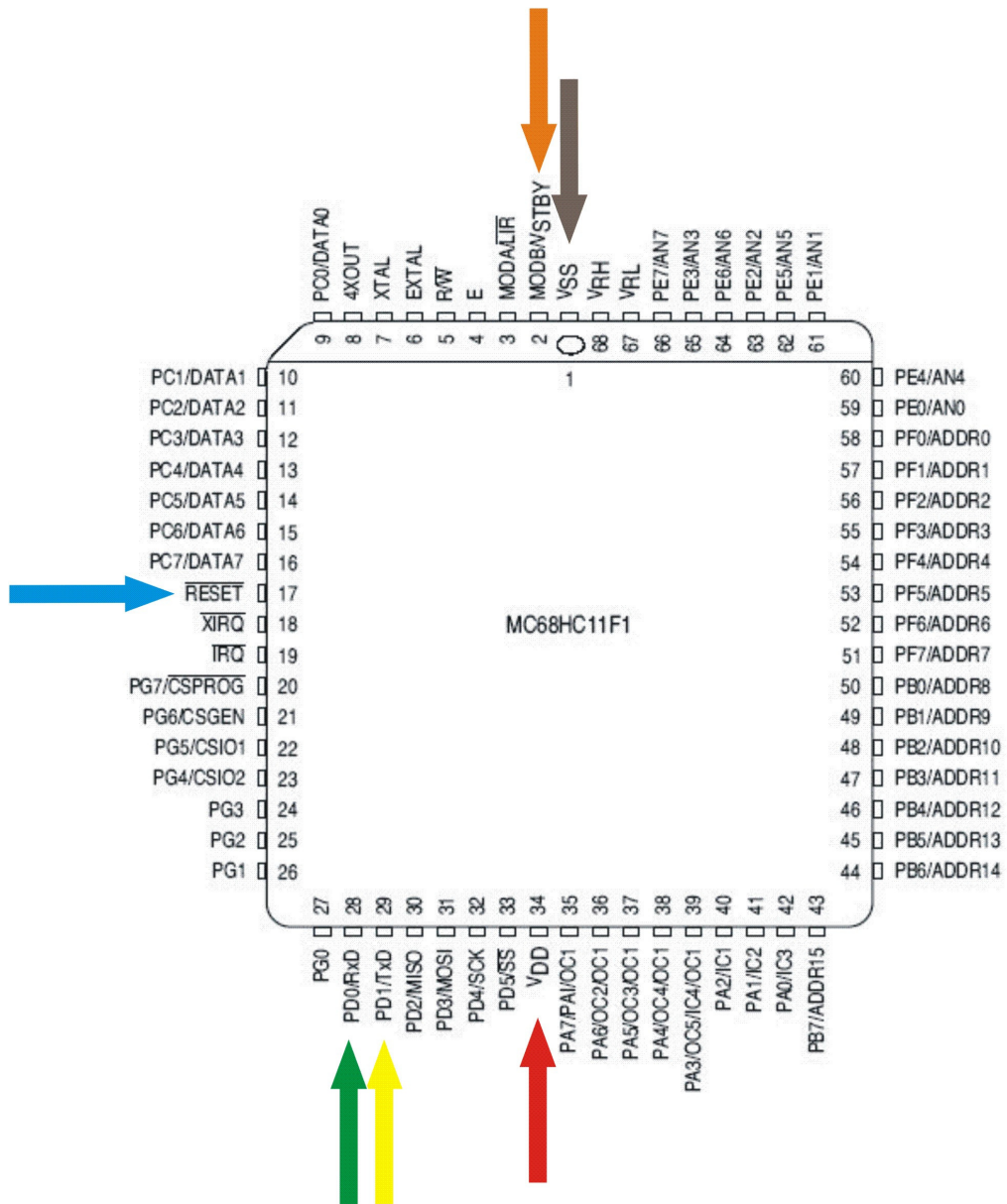

# CARPROG

## 5. MC68HC11K4, MC68HC711K4

MPU	Mask Set
MC68HC11K4	D43F
	E62H
	E75J
	K00W
MC68HC711K4	D67F
	K54X

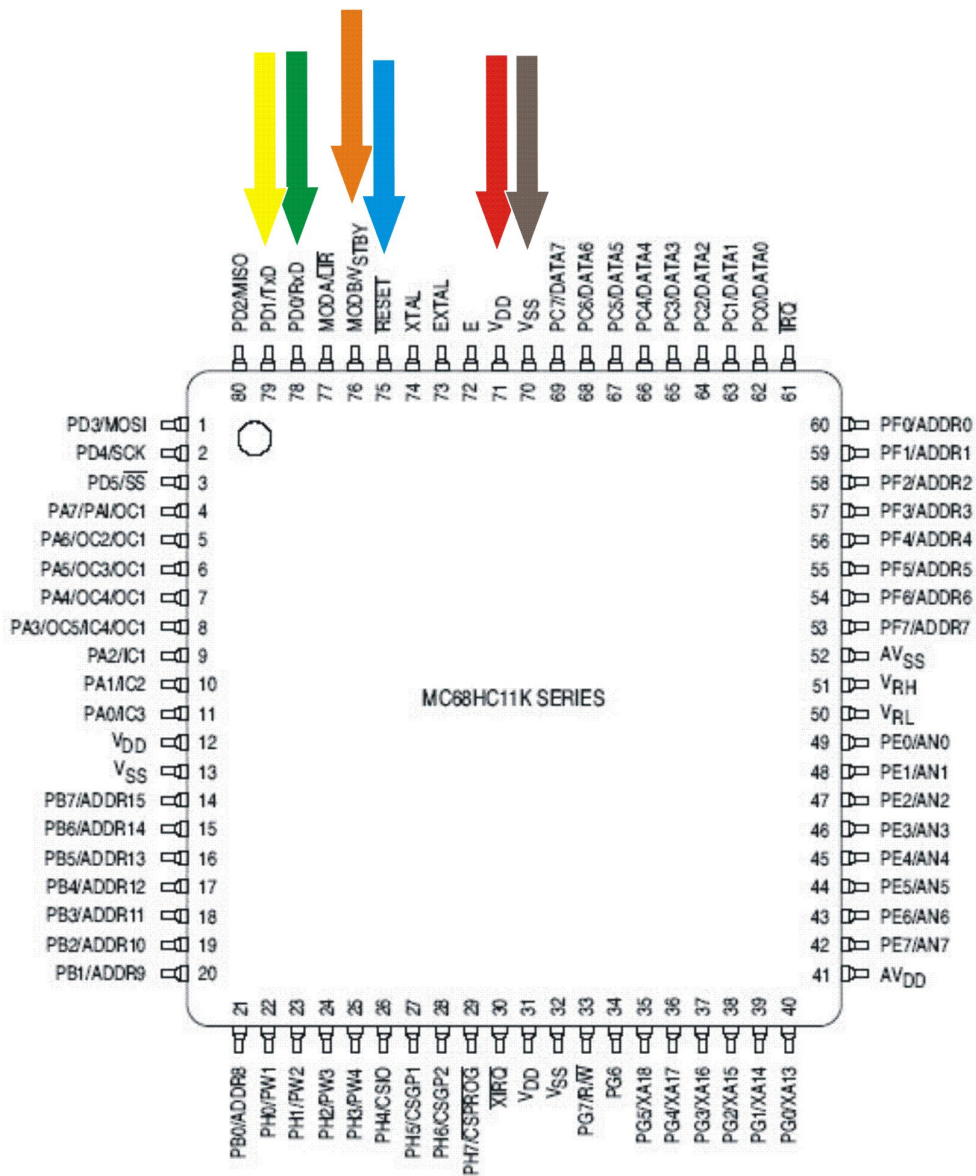

# CARPROG

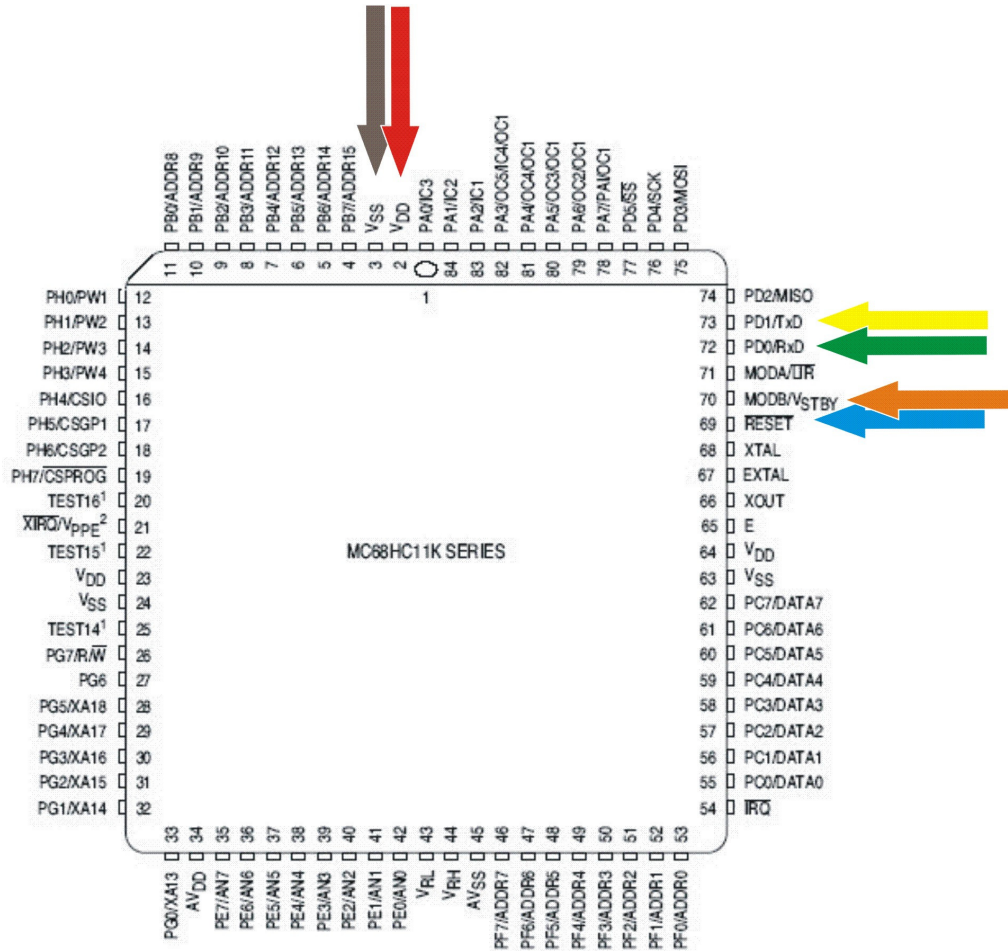

# CARPROG

## 6. MC68HC11KA4, MC68HC711KA4

MPU	Mask Set
MC68HC11KA4	E57S
	E59B
	F60M
	H95B
MC68HC711KA4	D61N

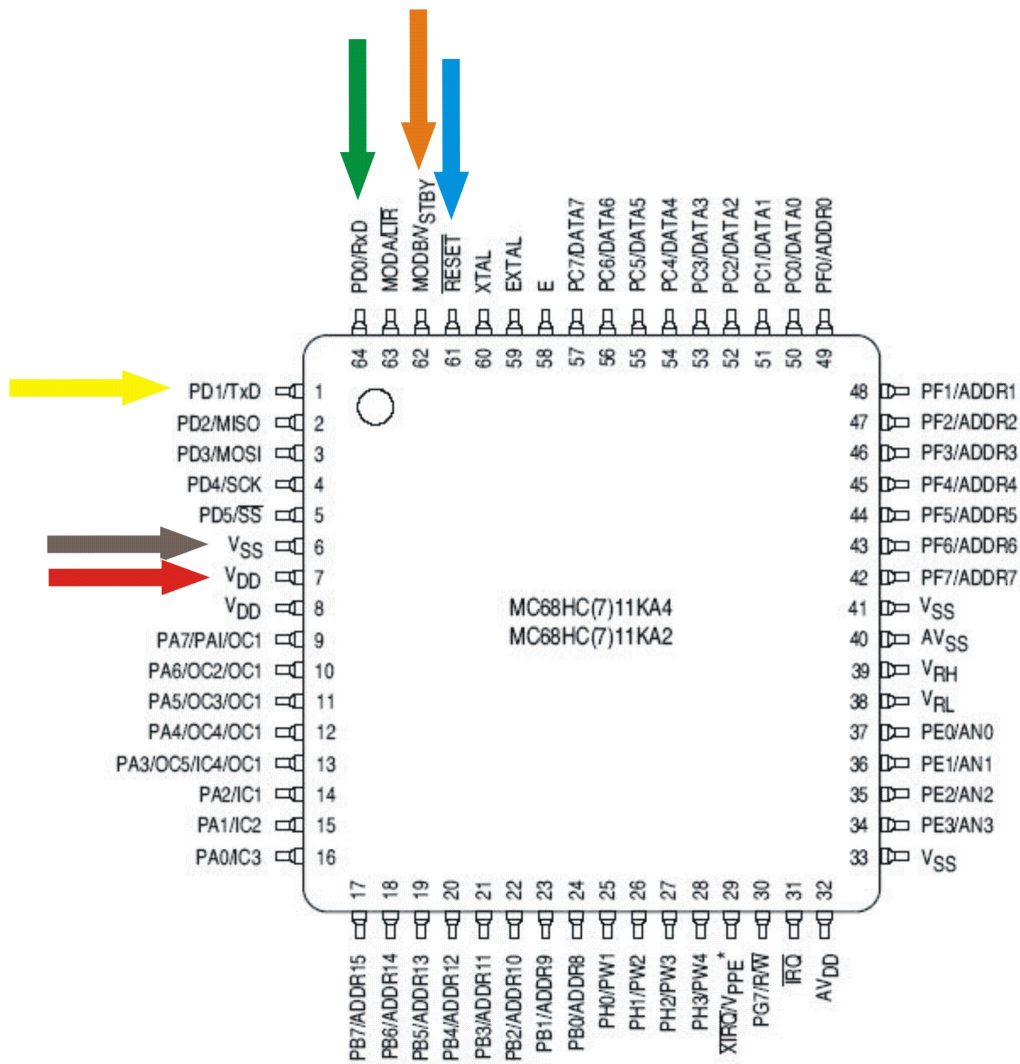

# CARPROG

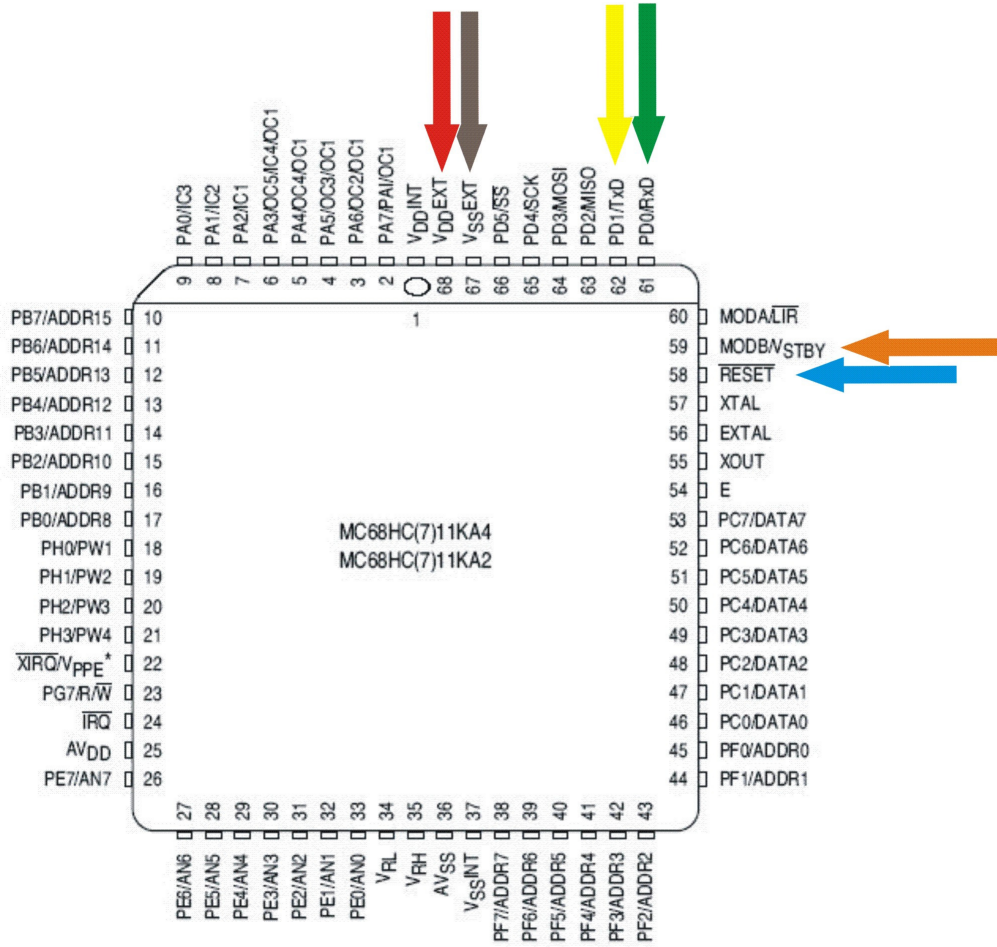

# CARPROG

## 7. MC68HC11KG4, MC68HC711KG4

MPU	Mask Set
MC68HC11KG4	G32V F53E
MC68HC711KG4	H86A

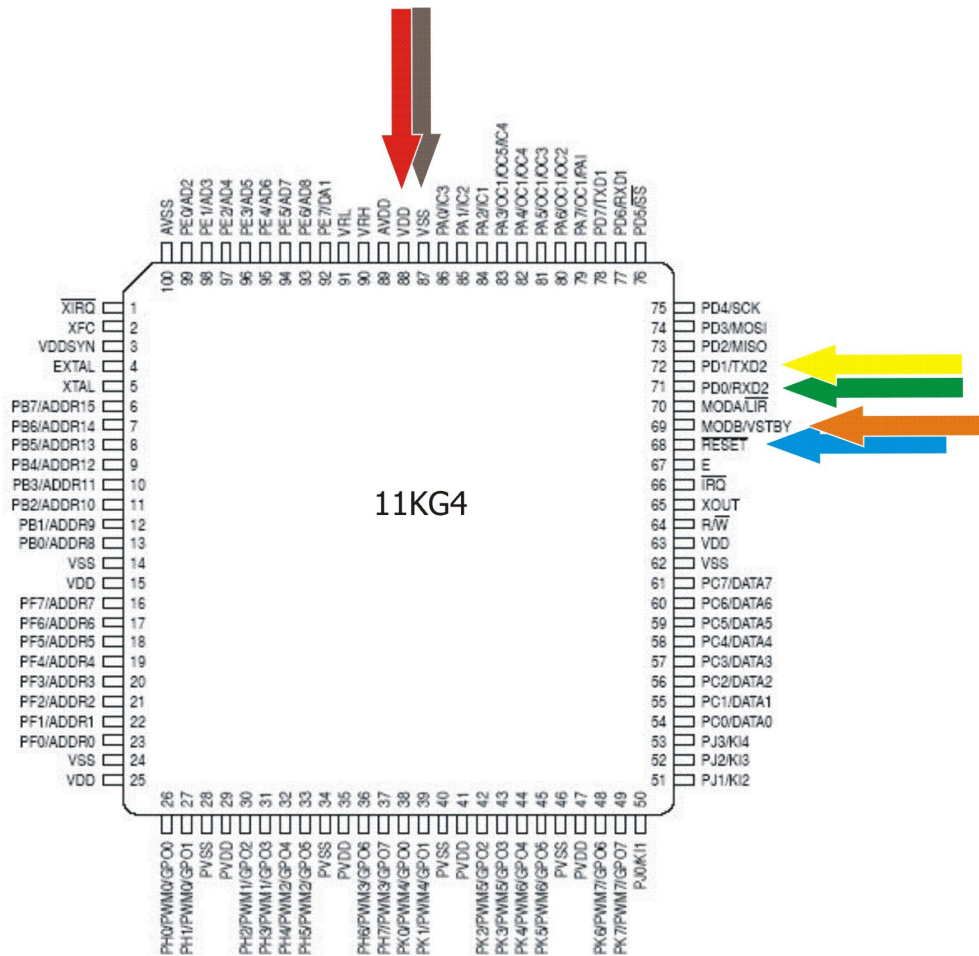



**8. MC68HC11KW1**

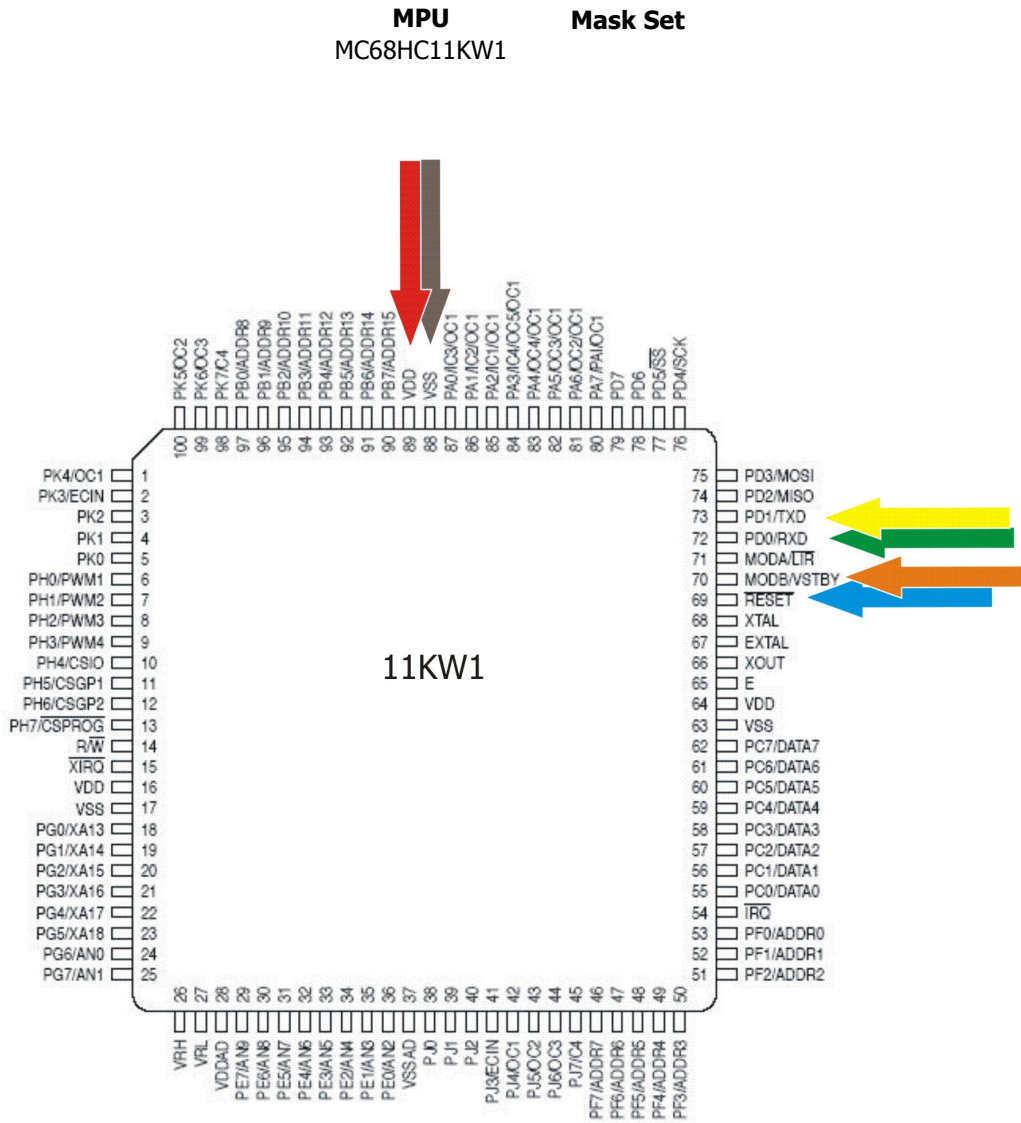

**9. MC68HC11PH8, MC68HC711PH8**

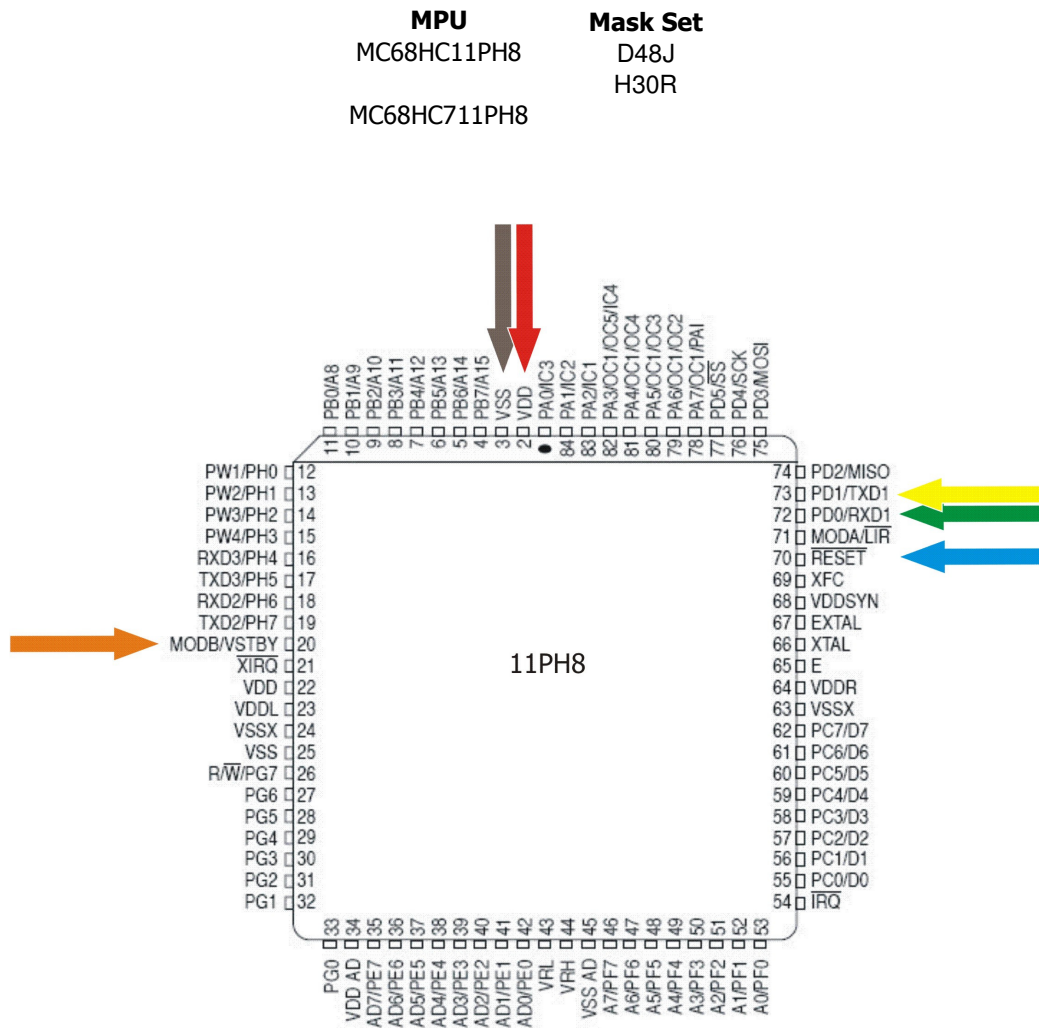

**10. MC68HC11P2, MC68HC711P2**

MPU	Mask Set
MC68HC11P2	D48J H30R
MC68HC711P2	D99H E53M

# CARPROG

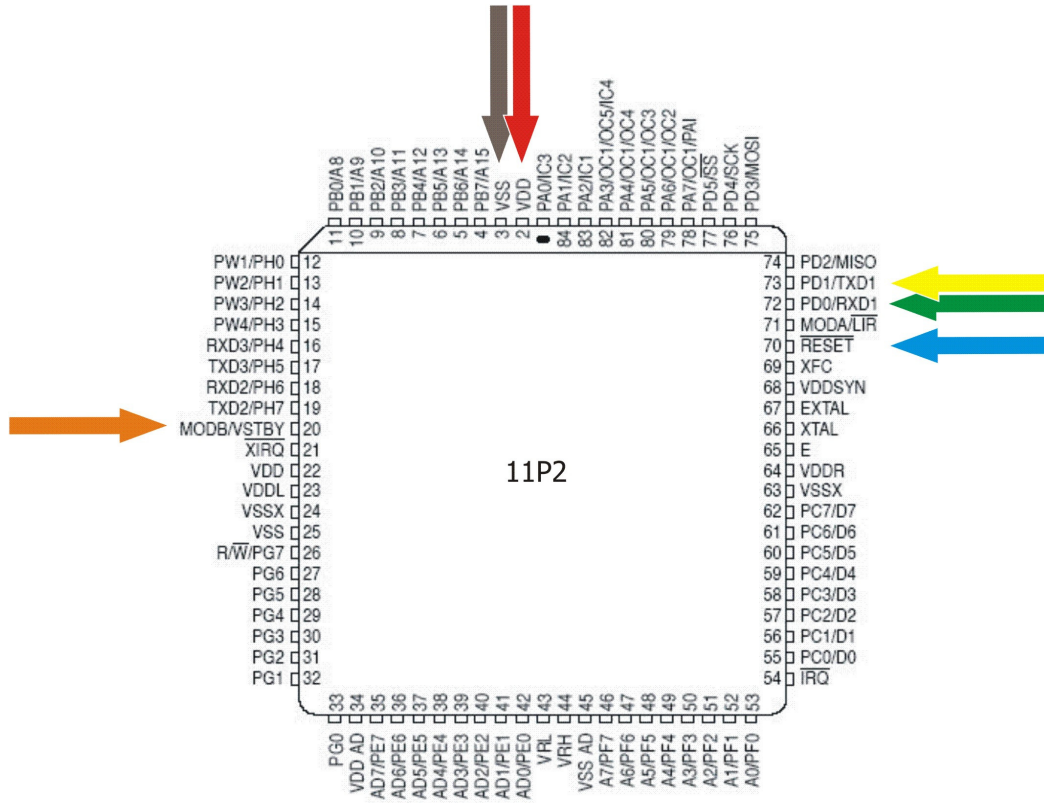

# CARPROG

