



Component-Level Electronic-Assembly Repair (CLEAR) Spacecraft Circuit Diagnostics by Analog and Complex Signature Analysis

*Richard C. Oeftering and Raymond P. Wade
Glenn Research Center, Cleveland, Ohio*

*Alain Izadnegahdar
ASRC Aerospace Corporation, Cleveland, Ohio*

NASA STI Program . . . in Profile

Since its founding, NASA has been dedicated to the advancement of aeronautics and space science. The NASA Scientific and Technical Information (STI) program plays a key part in helping NASA maintain this important role.

The NASA STI Program operates under the auspices of the Agency Chief Information Officer. It collects, organizes, provides for archiving, and disseminates NASA's STI. The NASA STI program provides access to the NASA Aeronautics and Space Database and its public interface, the NASA Technical Reports Server, thus providing one of the largest collections of aeronautical and space science STI in the world. Results are published in both non-NASA channels and by NASA in the NASA STI Report Series, which includes the following report types:

- **TECHNICAL PUBLICATION.** Reports of completed research or a major significant phase of research that present the results of NASA programs and include extensive data or theoretical analysis. Includes compilations of significant scientific and technical data and information deemed to be of continuing reference value. NASA counterpart of peer-reviewed formal professional papers but has less stringent limitations on manuscript length and extent of graphic presentations.
- **TECHNICAL MEMORANDUM.** Scientific and technical findings that are preliminary or of specialized interest, e.g., quick release reports, working papers, and bibliographies that contain minimal annotation. Does not contain extensive analysis.
- **CONTRACTOR REPORT.** Scientific and technical findings by NASA-sponsored contractors and grantees.

- **CONFERENCE PUBLICATION.** Collected papers from scientific and technical conferences, symposia, seminars, or other meetings sponsored or cosponsored by NASA.
- **SPECIAL PUBLICATION.** Scientific, technical, or historical information from NASA programs, projects, and missions, often concerned with subjects having substantial public interest.
- **TECHNICAL TRANSLATION.** English-language translations of foreign scientific and technical material pertinent to NASA's mission.

Specialized services also include creating custom thesauri, building customized databases, organizing and publishing research results.

For more information about the NASA STI program, see the following:

- Access the NASA STI program home page at <http://www.sti.nasa.gov>
- E-mail your question via the Internet to help@sti.nasa.gov
- Fax your question to the NASA STI Help Desk at 443-757-5803
- Telephone the NASA STI Help Desk at 443-757-5802
- Write to:
NASA Center for AeroSpace Information (CASI)
7115 Standard Drive
Hanover, MD 21076-1320



Component-Level Electronic-Assembly Repair (CLEAR) Spacecraft Circuit Diagnostics by Analog and Complex Signature Analysis

*Richard C. Oeftering and Raymond P. Wade
Glenn Research Center, Cleveland, Ohio*

*Alain Izadnegahdar
ASRC Aerospace Corporation, Cleveland, Ohio*

National Aeronautics and
Space Administration

Glenn Research Center
Cleveland, Ohio 44135

Trade names and trademarks are used in this report for identification only. Their usage does not constitute an official endorsement, either expressed or implied, by the National Aeronautics and Space Administration.

Level of Review: This material has been technically reviewed by technical management.

Available from

NASA Center for Aerospace Information
7115 Standard Drive
Hanover, MD 21076-1320

National Technical Information Service
5301 Shawnee Road
Alexandria, VA 22312

Available electronically at <http://gltrs.grc.nasa.gov>

Summary

The Component-Level Electronic-Assembly Repair (CLEAR) project at the NASA Glenn Research Center is aimed at developing technologies that will enable space-flight crews to perform in situ component-level repair of electronics on Moon and Mars outposts, where there is no existing infrastructure for logistics spares. These technologies must provide effective repair capabilities yet meet the payload and operational constraints of space facilities. Effective repair depends on a diagnostic capability that is versatile but easy to use by crew members that have limited training in electronics. CLEAR studied two techniques that involve extensive precharacterization of “known good” circuits to produce graphical signatures that provide an easy-to-use comparison method to quickly identify faulty components.

Analog Signature Analysis (ASA) allows relatively rapid diagnostics of complex electronics by technicians with limited experience. Because of frequency limits and the growing dependence on broadband technologies, ASA must be augmented with other capabilities. To meet this challenge while preserving ease of use, CLEAR proposed an alternative called Complex Signature Analysis (CSA). Tests of ASA and CSA were used to compare capabilities and to determine if the techniques provided an overlapping or complementary capability. The results showed that the methods are complementary.

Contents

Summary	iii
1.0 Introduction	1
2.0 Documents.....	2
2.1 Reference Documents	2
2.2 Applicable Documents.....	2
3.0 Electronics Diagnostics in Space	3
3.1 Lunar Mission Constraints.....	3
3.2 Flight Crew Constraints	3
4.0 Approach to Diagnostics	4
4.1 Known Good, or “Gold,” Signature Circuit Characterization	4
4.2 Analog and Complex Signature Analysis Techniques.....	4
5.0 Analog Signature Analysis.....	5
5.1 Description of Huntron Unit	5
5.2 Analog Signature Analysis Operating Principles.....	5
5.3 Huntron Tracker Model 30 Operating Settings.....	6
6.0 Complex Signature Analysis	8
6.1 Introduction to the Radiofrequency Vector Network Analyzer	8
6.2 Principles of Complex Impedance	8
6.3 Complex Signature.....	9
7.0 Operational Comparison of Analog Signature Analysis and Complex Signature Analysis.....	11
7.1 Analog Signature Analysis Operations	11
7.2 Complex Signature Analysis Operations	11
8.0 Side-by-Side Test Comparison of Analog Signature Analysis and Complex Signature Analysis.....	12
8.1 Actual Test Targets	12
8.2 Comparison Charts.....	13
8.3 Comparison Summary for Analog Signature Analysis and Complex Signature Analysis	22
9.0 Future Development.....	23
9.1 Instrument Development for Analog Signature Analysis and Complex Signature Analysis.....	23
9.2 Noncontact Diagnostic.....	23
10.0 Conclusions	24
Appendix.—Acronyms and Abbreviations.....	25
References.....	26

Component-Level Electronic-Assembly Repair (CLEAR) Spacecraft Circuit Diagnostics by Analog and Complex Signature Analysis

Richard C. Oeftering and Raymond P. Wade
National Aeronautics and Space Administration
Glenn Research Center
Cleveland, Ohio 44135

Alain Izadnegahdar
ASRC Aerospace Corporation
Cleveland, Ohio 44135

1.0 Introduction

The Component-Level Electronic-Assembly Repair (CLEAR) project is investigating techniques, tooling, and processes that could be used to perform nonterrestrial (space) repair of electronic assemblies. System maintenance on the International Space Station is based on orbital replaceable units (ORUs), which are encapsulated functional modules that allow the crew to remove and replace units with a minimum level of crew activity. These replaceable modules, however, are not optimized to minimize payload mass. In contrast, the ability to perform electronic repair at the board or component level would result in significant mass and volume savings.

To be effective, the repair process must first diagnose the specific components that contain the fault. Because of spacecraft and operational constraints, the equipment used in diagnosis should be small, compact, and simple to operate with a minimally trained crew member.

CLEAR investigated analog signature analysis (ASA) and complex signature analysis (CSA) techniques. Both techniques require extensive precharacterization to produce signatures of “known good” circuits. If the crew was supplied with known good, or “gold,” signatures, a simple comparison of the faulty circuit signature against the gold signature would indicate the faulty component. The operator would not need extensive electronics skill to perform this type of diagnosis.

ASA is an established technique that is widely used by the U.S. Navy for shipboard diagnostics. There are, however, limitations to ASA effectiveness, particularly for circuits like radiofrequency (RF) communications circuits. Therefore, the CLEAR project proposed an alternative technique more suitable for high frequencies and capable of exploiting circuit and component resonance properties. This study was performed to determine where ASA and CSA techniques would be effective and to determine if the techniques provided a complementary capability.

The CLEAR effort is being performed at the NASA Glenn Research Center and managed as part of the Exploration Technology Development Program’s Supportability Project based at the NASA Langley Research Center. The work also is being performed in concert with the U.S. Navy and the NASA Johnson Research Center. Acronyms used in this document are defined in the Appendix.

2.0 Documents

The following documents contain supplemental information related to the CLEAR task.

2.1 Reference Documents

Document number	Document title
CLEAR-ANA-002	Component-Level Electronic-Assembly Repair (CLEAR) Noncontact Coupling Techniques for Performing Signature Analysis

2.2 Applicable Documents

Document number	Document title
CLEAR-ANA-001	Component-Level Electronic-Assembly Repair (CLEAR) Life-Cycle Cost Impacts of Different Approaches for In Situ Maintenance of Electronics Hardware
CLEAR-DOC-001	Component-Level Electronic-Assembly Repair (CLEAR) Component Repair Experiment 1 (CRE-1) Flight System Requirements Document
CLEAR-DOC-002	Component-Level Electronic-Assembly Repair (CLEAR) Component Repair Experiment 1 (CRE-1) Concept and Hardware Summary
CLEAR-DOC-003	Component-Level Electronic-Assembly Repair (CLEAR) Recommendations for the Design of Electronic Assemblies for NASA's Exploration Program
CLEAR-DOC-004	Component-Level Electronic-Assembly Repair (CLEAR) Trade Study: Current Technologies and Instruments for Electronic Fault Diagnosis and Repair
CLEAR-DOC-005	Component-Level Electronic-Assembly Repair (CLEAR) Analysis of the Problem Reporting and Corrective Action (PRACA) Database of the International Space Station On-Orbit Electrical Systems
CLEAR-DOC-006	Component-Level Electronic-Assembly Repair (CLEAR) Assessment of Constellation Program In-Space Electronic Diagnostics and Repair Needs
CLEAR-DOC-007	Component-Level Electronic-Assembly Repair (CLEAR) Operational Concept
CLEAR-DOC-008	Component-Level Electronic-Assembly Repair (CLEAR) System Architecture
CLEAR-DOC-009	Component-Level Electronic-Assembly Repair (CLEAR) Recommendations for Enabling Manual Component-Level Electronic Repair for Future Space Missions
CLEAR-RPT-001	Component-Level Electronic-Assembly Repair (CLEAR) Component Repair Experiment 1 (CRE-1) System Requirements Review (SRR) Panel Report
CLEAR-RPT-002	Component-Level Electronic-Assembly Repair (CLEAR) Soldering in Reduced Gravity Experiment (SoRGE) Mission Test Report
CLEAR-RPT-004	Component-Level Electronic-Assembly Repair (CLEAR) Synthetic Instrument Capabilities Assessment and Test Report

3.0 Electronics Diagnostics in Space

3.1 Lunar Mission Constraints

Future space exploration missions will require highly efficient methods for repairing electronic equipment to ensure the safety of the crew. For the International Space Station (ISS), the systems are composed of modular ORUs. When system faults are discovered on ISS, they are traced down to the specific faulty ORU, which is then replaced with an on-orbit spare. The faulty ORUs are returned to Earth via the space shuttle for repair and then relaunch aboard a later space shuttle flight. The ORU approach simplifies the maintenance of flight systems, but it is based on the premise that the crew is supported by a robust and timely logistics infrastructure.

In lunar surface operations, spares are expected to be very scarce because of the extreme payload limitations. The availability of logistics is also expected to be much more constrained. Return of hardware to Earth for repair is not an option. This drives the program toward a low logistics strategy where faulty hardware repairs are performed in situ at the component level. In comparison, a component may weigh between 1/100 and 1/1000 of the weight of the complete ORU. As a result, the mass dedicated to spare components is much less and far more efficient than with ORU spares.

Component repair must be supported by effective diagnostics. If the process of diagnosing the fault, replacing the component, and functionally testing the repaired unit consumes too much time and requires substantial mass in equipment, then the benefits of component-level repair are diminished. The diagnostics tools must be effective, compact, and easy to use.

3.2 Flight Crew Constraints

The size of space-flight crews will continue to be small. Lunar missions are expected to be composed of no more than four crew members. Because of the many crew activities required to achieve mission objectives, crew time and training are very constrained. The crew can perform routine maintenance, but when faults arise in complex electronic systems, the crew must rely on ground support to locate faults via telemetry. The normal telemetry on ISS is effective at identifying faults to the ORU level, but the problem history has shown that component-level problems are beyond the reach of telemetry. A similar situation is expected to exist for lunar operations. External equipment is required for component-level diagnostics. This equipment must be easy to use and quickly understood by a crew that has a minimum level of training in electronics diagnostics.

4.0 Approach to Diagnostics

4.1 Known Good, or “Gold,” Signature Circuit Characterization

Comparative signature techniques allow nonspecialist personnel to identify defective components on an electronic board. A power-off technique called ASA developed by Huntron has been used by the U.S. Navy as a simple, but effective, form of diagnostics. The basic idea comes from a voltage-current ($V-I$) curve tracer that is used for individual component characterization. The U.S. Navy’s Gold Disk program records and distributes known-good-board ASA data on specific circuits throughout the Navy. The Gold Disk (a compact disk) in combination with an ASA unit provides a simple-to-use, initial screening test that can isolate many simple faults. The concept of characterizing known good circuits and using the characteristic signatures as a basis of comparison is common throughout the electronics industry for electronics, from circuit board assemblies to individual silicon dies.

4.2 Analog and Complex Signature Analysis Techniques

The ASA technique characterizes the performance of individual networks and compares them with known-good-board data. This is done by connecting to a common ground point on the board being tested, and injecting a signal into a network. The signal is a low-level, low-frequency, sinusoidal input. This signal is used to generate a $V-I$ relationship for the components attached to the specific network curve. A faulty component changes the shape of the $V-I$ curve. When the faulty trace is overlaid on a “gold” trace, any difference is easy to identify.

CLEAR is advancing the approach by measuring complex impedance in the frequency domain. The CSA approach exploits network analyzer technology to reveal frequency-dependent behaviors and exploit self-resonant and network-resonant characteristics to isolate faults. It can also reveal the resonant behaviors of devices that are physically isolated from the node. It can even detect breaks in circuit card vias and traces. The high-frequency capability also makes it suitable for direct measurement of high-frequency RF circuits.

5.0 Analog Signature Analysis

5.1 Description of Huntron Unit

A power-off technique called ASA developed by Huntron, Inc., is a simple, but effective, form of diagnostics based on comparison with a known good board. It provides the advantage of diagnosing a circuit in the power-off condition, which negates the need for power supplies and the risks posed by powering up a faulty circuit.

The ASA technique applies a current-limited sine-wave voltage to an unpowered circuit or electronic component. The resulting $V-I$ characteristic (analog signature) is then stored and displayed for comparisons to signatures of a known good circuit card or electronic component. Circuit cards and electronic components can be diagnosed without applying external power.

5.2 Analog Signature Analysis Operating Principles

A single component that can be isolated provides a very predictable curve. However circuits usually have multiple devices on each node; thus a node will have a signature that is a composite of multiple devices. As long as the settings and probe positions are consistent, the signature should accurately duplicate the known-good-board signature (Ref. 1).

As shown in Figure 1, a personal computer workstation with ASA software graphically displays the analog signature. This approach can be applied to any type of passive component like a resistor, capacitor, or inductor. It can also be applied to solid-state semiconductor components like diodes, transistors, silicon-controlled rectifiers, and digital, analog, or mixed-signal (ICs).

Alternatively, the signature can be compared with known node faults, where individual components with various fault modes can be precharacterized and thus provide a more precise diagnosis (Figure 2). A skilled user that is familiar with the circuit design and each component's function can determine exactly which component is faulty. If the user is not skilled and no known good reference is available, then the results will be ambiguous.

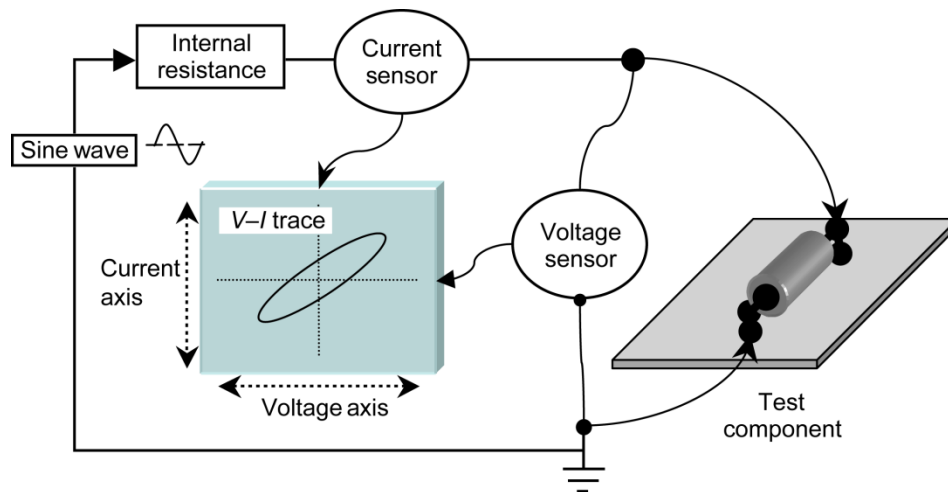

Figure 1.—Analog Signature Analysis (ASA) relies on measuring the response to a very low power sine wave signal, $V-I$, voltage-current.

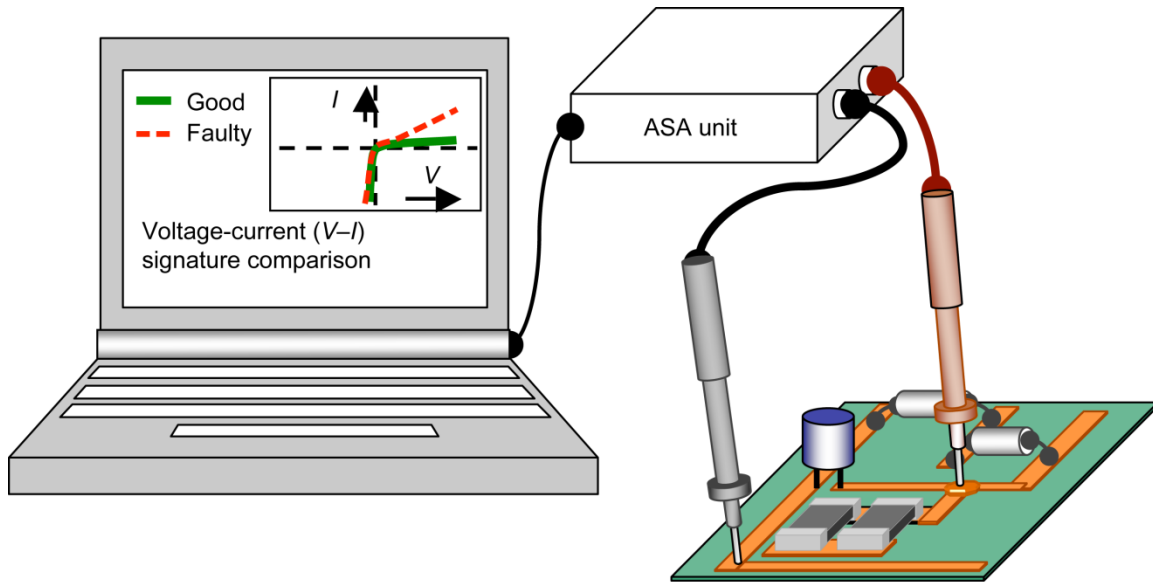

Figure 2.—Analog Signature Analysis (ASA) characterization may involve several individual devices contributing to the node's characteristic signature. A fault in any component should alter the signature.

5.3 Huntron Tracker Model 30 Operating Settings

Operating settings for the Huntron device follow:

- Open-circuit peak voltage (24 settings)
 - 200, 400, 600, and 800 mV
 - 1 to 20 V (in 1-V steps)
- Internal source resistance
 - 10, 20, 50, 100, 200, and 500 Ω
 - 1, 2, 50, and 100 k Ω
 - 54, 1.2, and 26.7 k Ω
- Short-circuit current limit, 200 mA
- Signal frequency
 - 20 to 190 Hz (in 10-Hz steps)
 - 200 Hz to 1.9 kHz (in 100-Hz steps)
 - 2 to 5 kHz (in 1-kHz steps)

A power supply board and an RF amplifier were used as an example application of the ASA procedure. Huntron equipment provides a maximum driving alternative signal of 3.0 V and a maximum frequency of 200 Hz. See the sample output in Figure 3.

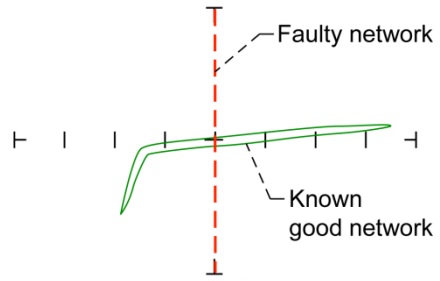

Figure 3.—Analog Signature Analysis (ASA)
sample output of current-voltage curve
obtained with the Huntron unit.

6.0 Complex Signature Analysis

6.1 Introduction to the Radiofrequency Vector Network Analyzer

CSA becomes an extension of ASA by using the capability of an RF vector network analyzer. Not to be confused with network protocol analyzers, an RF vector network analyzer (see Figure 4) is intended to test networks of components in high-frequency alternating-current (AC) signal circuits. These devices share certain capabilities with a spectrum analyzer. They are generally used for high-frequency or RF circuits, where operating frequencies can range from 10 kHz to 110 GHz.

Vector network analyzers are used to measure the frequency-domain properties of component networks rather than the properties of single components. They inject a signal into a network and measure the signal reflecting back from the circuit and the signal transmitted through the circuit. They are commonly used to test high-frequency amplifiers, filters, and tuning networks and can also test piezoelectric devices like crystal resonators. They operate at very low wattage and inject signals into unpowered passive networks, such as filters, or powered active devices, such as amplifiers.

6.2 Principles of Complex Impedance

For CLEAR, the Agilent 8712ET RF Network Analyzer provides a complex impedance measurement. Network analyzers make their measurements relative to a reference impedance value (typically 50 Ω for RF systems). The scale can be very large, and thus a log scale is often used and impedance ratio is displayed in decibels (Ref. 2).

Complex impedance (Z) is a complex value; that is, it is composed of real and imaginary components:

$$Z = R + X_i$$

where R is resistance (the real component) and X_i is reactance (represented by an imaginary component). The resistance term R is commonly measured with a direct-current (DC) resistance meter. The reactance term (X) typically involves inductors or capacitors and is only meaningful for AC signals. The reactance is frequency dependent:

$$X_i = \frac{1}{\omega C} \quad \text{or} \quad X = \omega L$$

where C is capacitance, L is inductance, and ω is frequency.

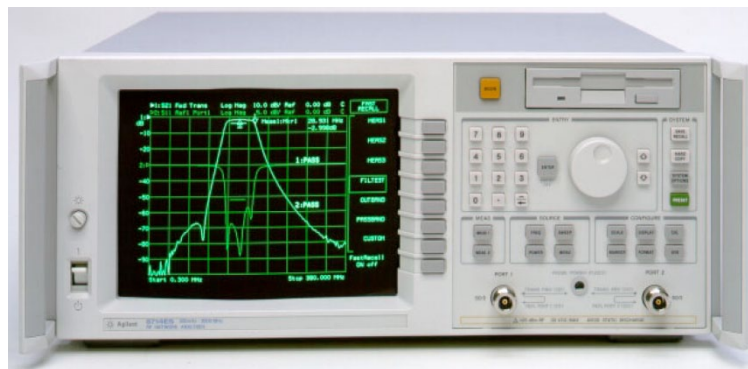

Figure 4.—Full-featured radiofrequency vector network analyzer that operates in the 300-kHz to 1.3-GHz frequency range.

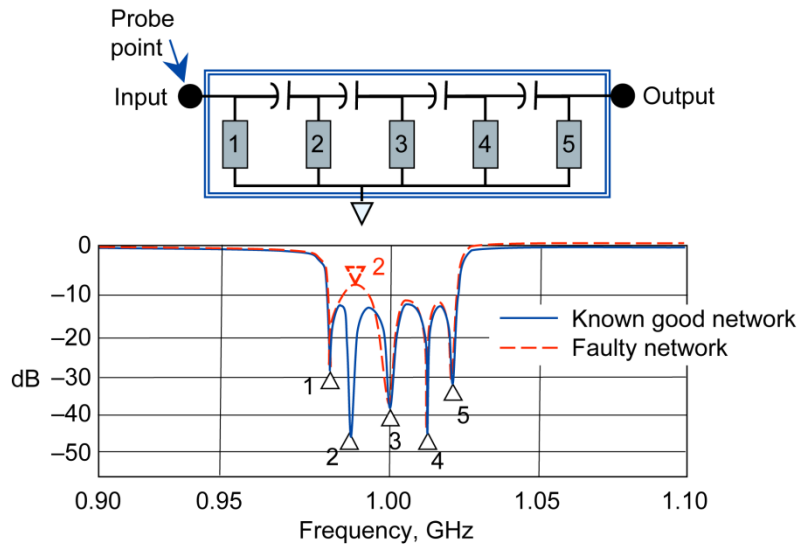

Figure 5.—Normal resonance of a known good five-component network (markers 1 to 5 on the solid trace) and a faulty component in a test circuit where element 2 has failed (marker 2 on the dashed trace).

A network analyzer uses a 50-Ω internal reference. The signal injected into the target and the subsequent reflections are compared with the same signal injected into a calibrated 50-Ω load.

The 50-Ω reference limits the sensitivity of the network analyzer for impedances that are substantially different from 50 Ω. For example, a circuit with a constant impedance of 100 000 Ω will show a flat response. However, inductor and capacitor impedance values will change substantially over a wide frequency range. As with the ASA approach, the user should select settings that enhance the sensitivity of the measurement.

By performing a wide frequency sweep, one may be able to identify specific components. By comparing the sweep signature to a known good, or “gold,” signature, one can quickly spot a failed component. As shown in Figure 5, the data may be very difficult to interpret directly but will provide a very distinct and unique signature, particularly for a circuit where the input impedance is near the reference impedance.

6.3 Complex Signature

As shown in Figure 5, a filter composed of several inductor/capacitor (LC) nodes has a distinct resonant condition for each node. The plots produced by the network analyzer could be used to characterize the network. The actual measurement is taken at the input end.

Note that markers 1 to 5 indicate distinct nodes and each node’s contribution to the characterization curve. Therefore, it is possible to characterize the network without measuring every node, which is particularly useful when the circuit is encapsulated and individual components are inaccessible. Note that the measurement is taken from the signal-injection side of the circuit rather than from the output. If any internal devices fail, it would appear as a distortion of the curve at that point. If internal component values are known from design data, then the problem component can be identified quickly.

Figure 6 shows an actual CSA data trace. The data are displayed as a combination of phase shift and polar plots from the Agilent Technologies 8712ET RF Network Analyzer. In the lab tests, these plots were determined to be the easiest for comparing good versus faulty components. Other plots such as the Smith Chart and various linear and log scale charts can be used depending on the level of impedance mismatch between the target and the internal reference.

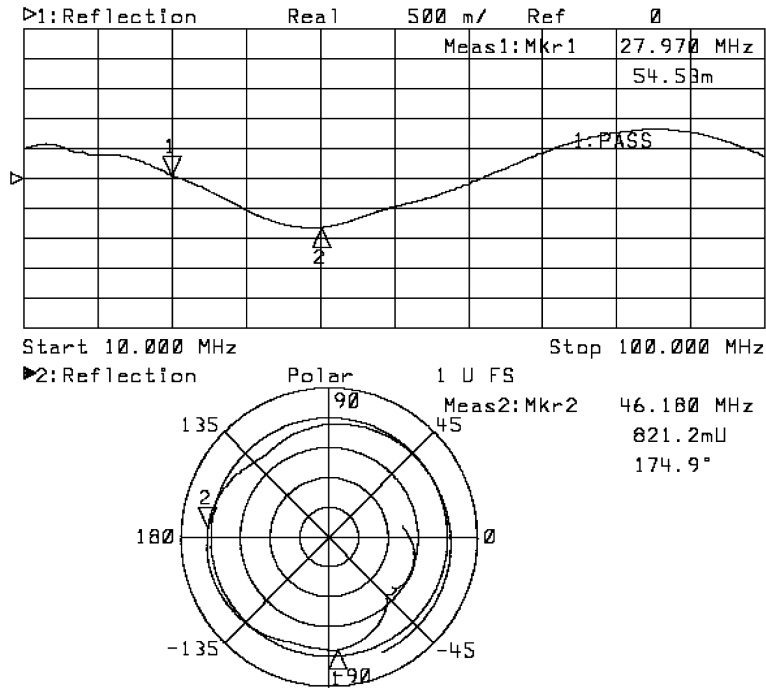

Figure 6.—Complex Signature Analysis (CSA) sample output showing both a phase plot and polar plots. Other data display options, such as a reflected power chart and a complex-impedance Smith Chart, are available but are more difficult to interpret by an untrained user.

7.0 Operational Comparison of Analog Signature Analysis and Complex Signature Analysis

7.1 Analog Signature Analysis Operations

ASA operation was performed using a Huntron instrument. A power supply board and an RF amplifier were used as example application for the ASA procedure. Huntron equipment provides a driving alternative signal of maximum 3.0 V and a frequency of 200 Hz. In order to verify the extent of usage of this technique, a variety of components were selected on the board. This selection includes passive components such as resistors and capacitors as well as active components: diodes, analog ICs, and digital ICs. An RF amplifier also was used for testing. However, because of the frequency limits of the Huntron unit, inductors at the input and output stages of the amplifier appear as short circuits. The captured data are in the form of a $V-I$ graph.

7.2 Complex Signature Analysis Operations

The Agilent 8712T RF Network Analyzer used for testing the CSA approach has a range of setup parameters:

- Frequency sweep
 - Minimum start frequency, 300 kHz
 - Maximum stop frequency, 1.3 GHz
- Number of samples per sweep, 201 to 1601
- Sweep rate, samples per second
- RF power input, -2 to 17 dBm

For our experiments, the highest frequency was limited to 100 MHz to prevent radiation through printed circuit board conductive lines. The same components that were tested with the Huntron instrument were tested with the network analyzer.

The analyzer has different options for presenting output data. These include amplitude and phase, or real and imaginary components in Cartesian (x/y plot) or polar graphs. For ease of visual inspection, a linear graph and a polar graph were selected. The measured quantities could be presented as real and imaginary or as amplitude and phase. In some cases, the change in the phase was more significant than the change in the amplitude of the output signal. Table I summarizes the comparative range of operating parameters for ASA and CSA.

TABLE I.—SUMMARY OF OPERATING PARAMETERS FOR ANALOG SIGNATURE ANALYSIS (ASA) AND COMPLEX SIGNATURE ANALYSIS (CSA)

Characteristic	ASA	CSA
Operating domain	Time domain	Frequency domain
Signal input	Low-frequency alternating current (AC)	Frequency sweep
Frequency range	20 Hz to 5 kHz	300 kHz to more than 1.2 GHz
Internal impedance	10 Ω to 100 k Ω	50 Ω
Voltage or power range	200 mV to 20 V	0 to 17 dBm
Target state	Power off	Power off

8.0 Side-by-Side Test Comparison of Analog Signature Analysis and Complex Signature Analysis

8.1 Actual Test Targets

For comparison tests, an available circuit board from a space experiment (Figure 7) was used. A custom power supply board and electronic components were used for tests by Huntron (ASA) and the network analyzer (CSA). Table II lists the tested components.

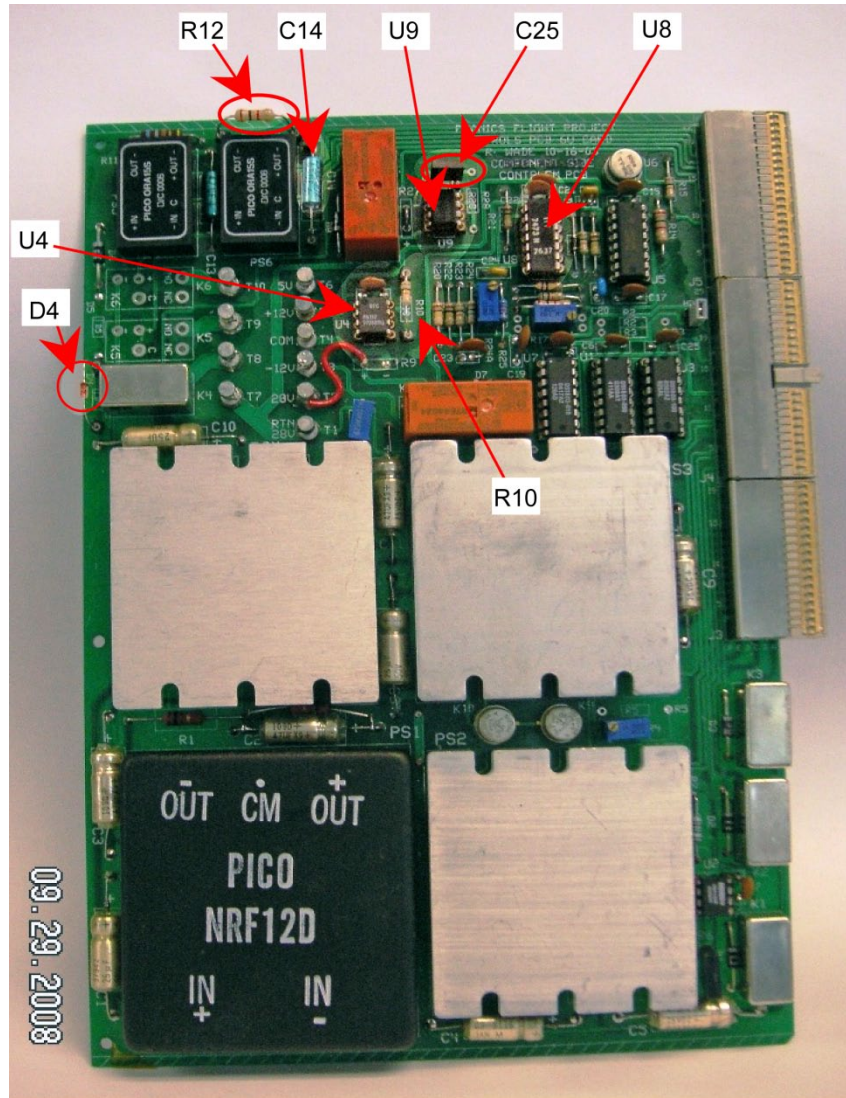

Figure 7.—Analog Signature Analysis (ASA) and complex signature analysis (CSA) test target composed of analog and digital circuit components. The highlighted components were subjected to ASA and CSA testing.

TABLE II.—COMPONENTS TESTED

Component designation	Component description	Test parameters
Resistors		
R10	0.25 W, 10 k Ω	Simulated fault value, 390 Ω
R12	0.5 W, 1 k Ω	Simulated fault value, 15 Ω ; not detected as a bad part by ASA
Capacitors		
C14	4.7- μ F electrolytic	Open
C25	0.22- μ F ceramic	Simulated fault value, 0.001 μ F
Diodes		
D4	IN914 diode	Shorted
Analog components		
U4	6N137 analog optocoupler	Damaged five of eight pins (1,3,6, 7, and 8)
U9	555 analog timer	Damaged three of eight pins (1, 6, and 8)
Digital components		
U8	7473 JK flip flop	Damaged 13 of 14 pins (1 to 4 and 6 to 14)
Radiofrequency (RF) circuit		
RF	CA282C Motorola 1-W wideband, linear RF amplifier	RF input and RF output pins

Creating damaged components is much more difficult than initially anticipated. Many components fail because of slow processes, such as corrosion or internal metal migration, and are very difficult to reproduce even in specially controlled environments. Faults due to overstressing by high current, over voltage or thermal damage tend to fail as open or short circuits. For discrete components, it was easier to simulate a fault by replacing the good component with another good component of a different value.

After many attempts, a set of faulty integrated circuits (ICs) were produced that were used as plug-in faults. They were functionally equivalent to the component in the original circuit card but some had slight differences in the electrical specifications. Since the objective is to evaluate ASA and CSA as an initial fault-finding technique, the differences were deemed to be acceptable for the test.

A 1-W wideband RF amplifier module was tested separately to demonstrate ASA and CSA for RF circuits. In this case, both damaged and good units were already available.

8.2 Comparison Charts

Figure 8 to Figure 20 provide samples of the tests performed and illustrate both ASA and CSA. The graphs for good and damaged components are shown side by side.

The analysis of the RF amplifier illustrates that ASA has limitations when used in high-frequency RF circuits. ASA data are not shown for RF circuits because ASA was unable to distinguish between a known good and a faulty amplifier circuit. It is common to use a special high-frequency transformer called a transmission line transformer. These RF devices respond to high frequency, but at low-frequency or DC currents they will appear as a short circuit. Although CSA should be well suited to RF devices, the differences between the good and faulty circuit are not dramatic. The original amplifier damage was due to overheating of the amplifier semiconductors. This fault is isolated somewhat by the intervening line transformers.

For consistency, in the amplifier tests, the amplitude versus frequency was plotted in linear and polar coordinates. For RF applications, reflected power and a Smith Chart to display complex impedance were more effective tools.

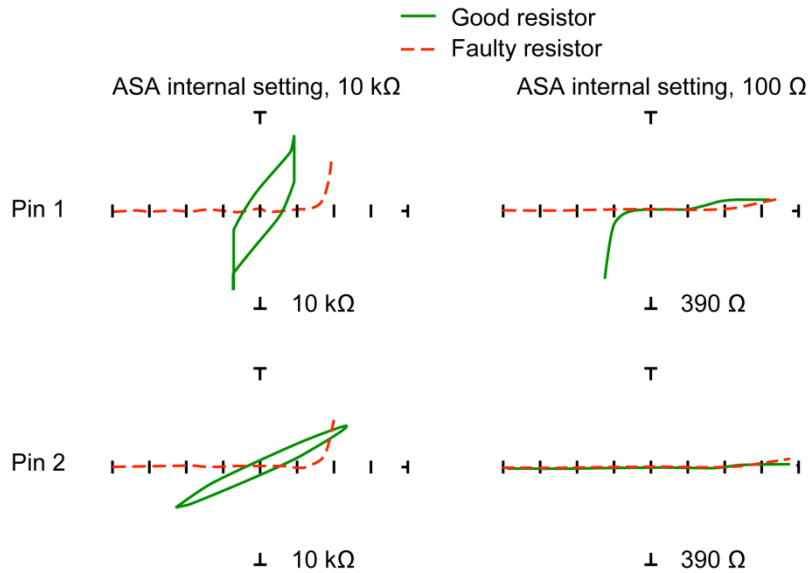

Figure 8.—Resistor (R10) tested by Analog Signature Analysis (ASA) at 3 V and 200 Hz on pins 1 and 2. It is easy to discern the differences between the ASA characteristics of the known good resistor and the faulty resistor at various ASA settings.

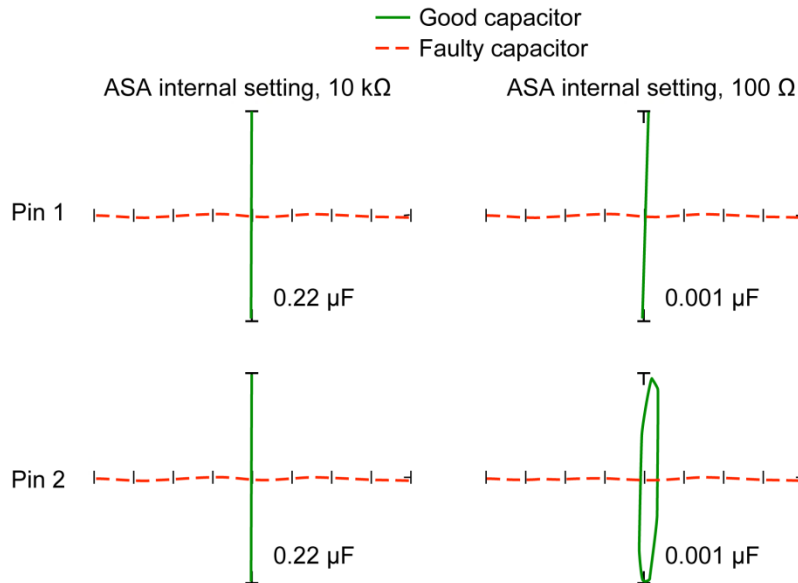

Figure 9.—Ceramic capacitor (C25) tested by Analog Signature Analysis (ASA) at 3 V and 200 Hz on pins 1 and 2. It is easy to discern the differences between the ASA characteristics of the known good capacitor and the faulty capacitor at various ASA settings. Internal resistances of 100 Ω and 10 kΩ provide roughly the same sensitivity.

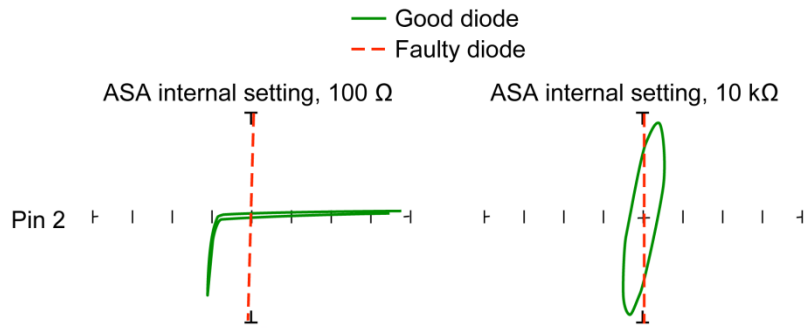

Figure 10.—Diode 1N914 (D4) tested by Analog Signature Analysis (ASA) at 3 V and 200 Hz on pin 2.

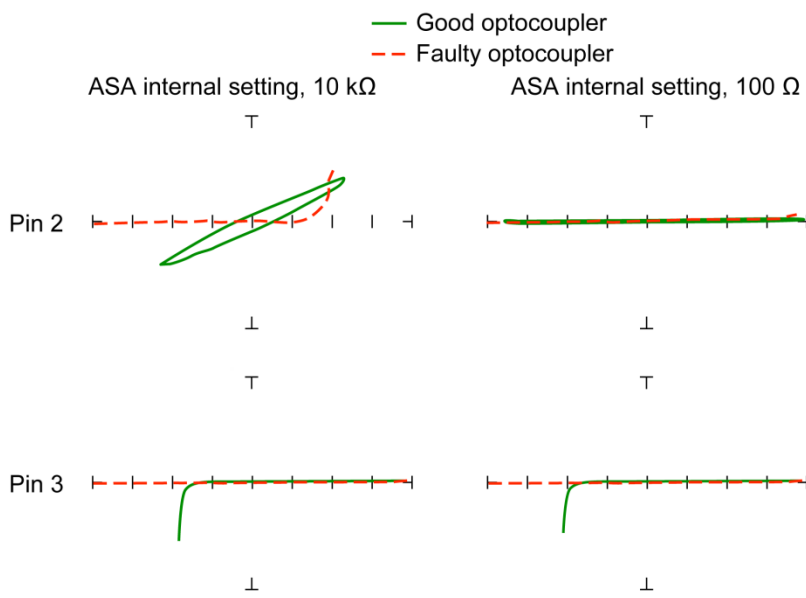

Figure 11.—Analog optocoupler 6N137 (U4) tested by Analog Signature Analysis (ASA) at 3 V and 200 Hz on pins 2 and 3 (internal diode connections). The 10-k Ω internal resistance setting is preferred.

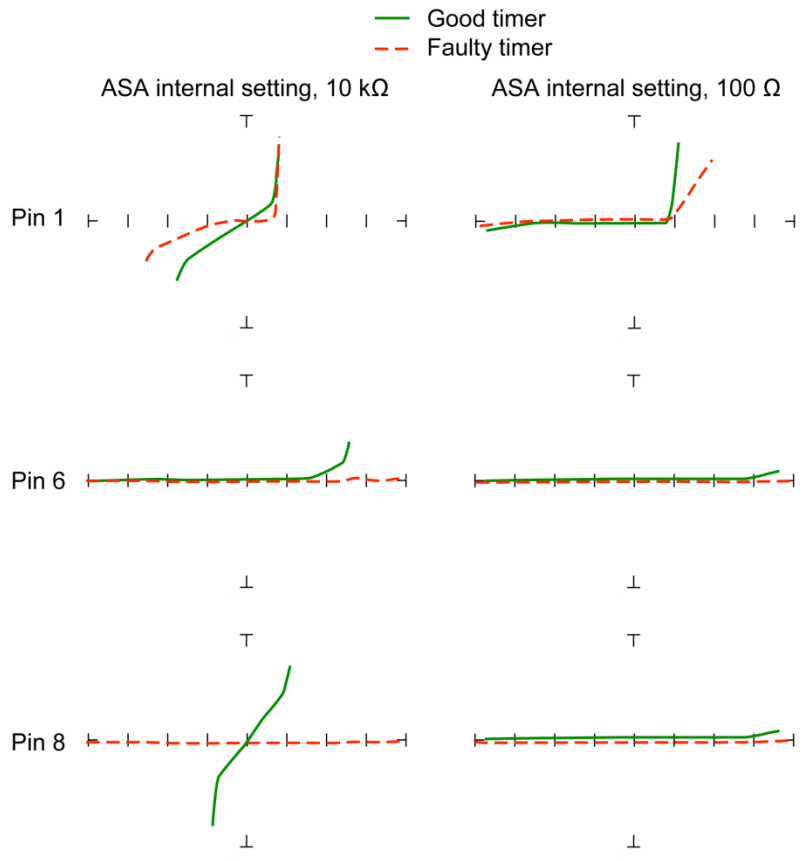

Figure 12.—Analog timer NE555 (U9) tested by Analog Signature Analysis (ASA) at 3 V and 200 Hz on pins 1, 6, and 8.

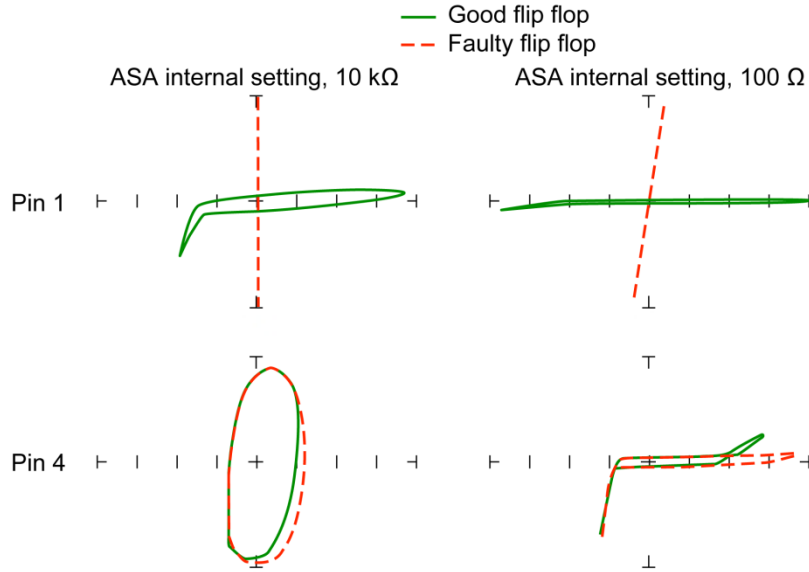

Figure 13.—Digital circuit 7473 flip flop (U8) tested by Analog Signature Analysis (ASA) at 3 V and 200 Hz on pins 1 and 4. Digital circuits have relatively high impedance at the input ports; thus, the 10-kΩ setting is a more responsive indicator of faults.

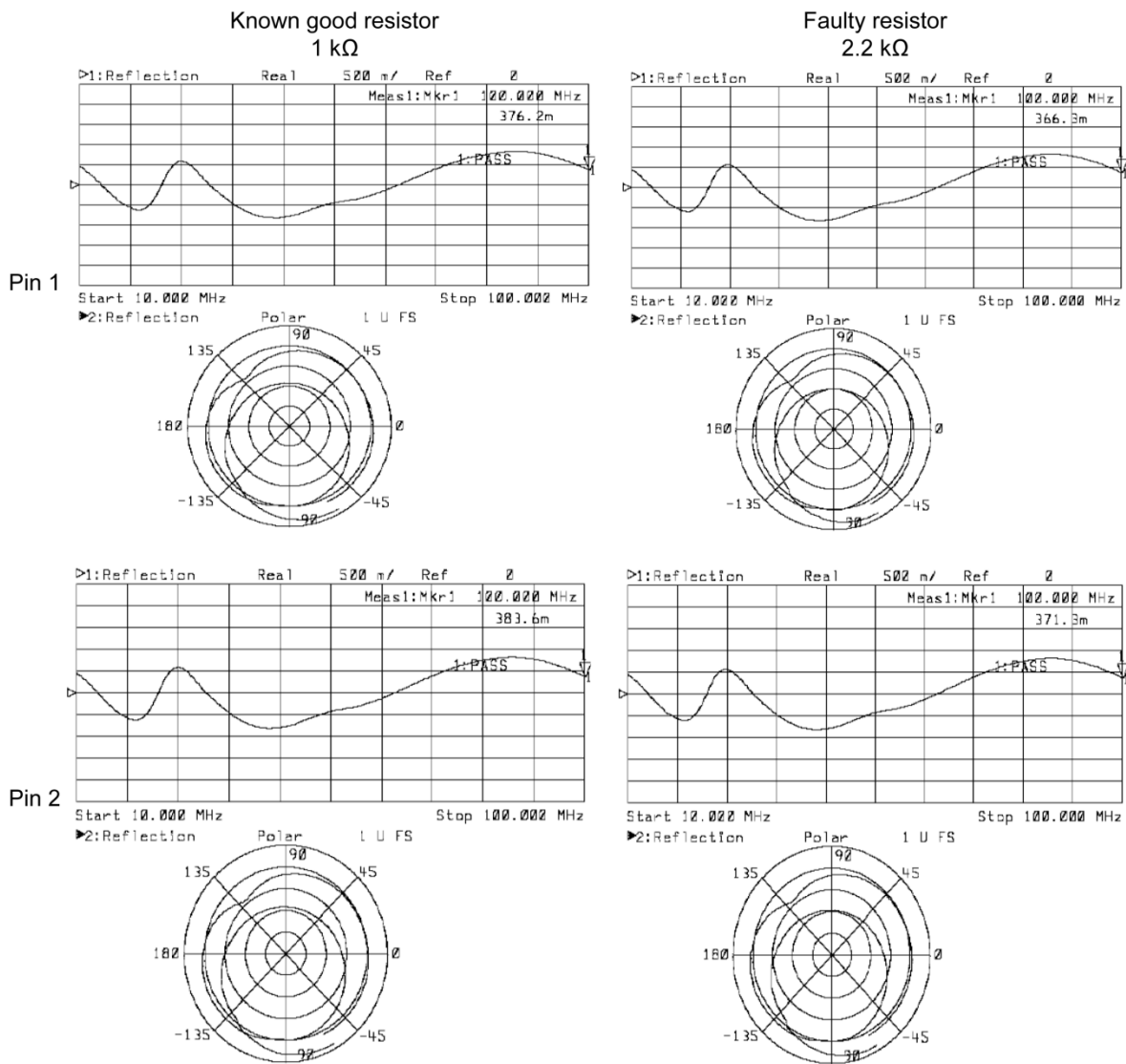

Figure 14.—Resistor (R12) tested by Complex Signature Analysis (CSA) from 10 to 100 MHz on pins 1 and 2. No significant change is visible. The reason may be that 2.2 kΩ is relatively high in comparison to the 50-Ω reference impedance. A resistor will have only a very small reactive component, so complex impedance is not an effective indicator for this application.

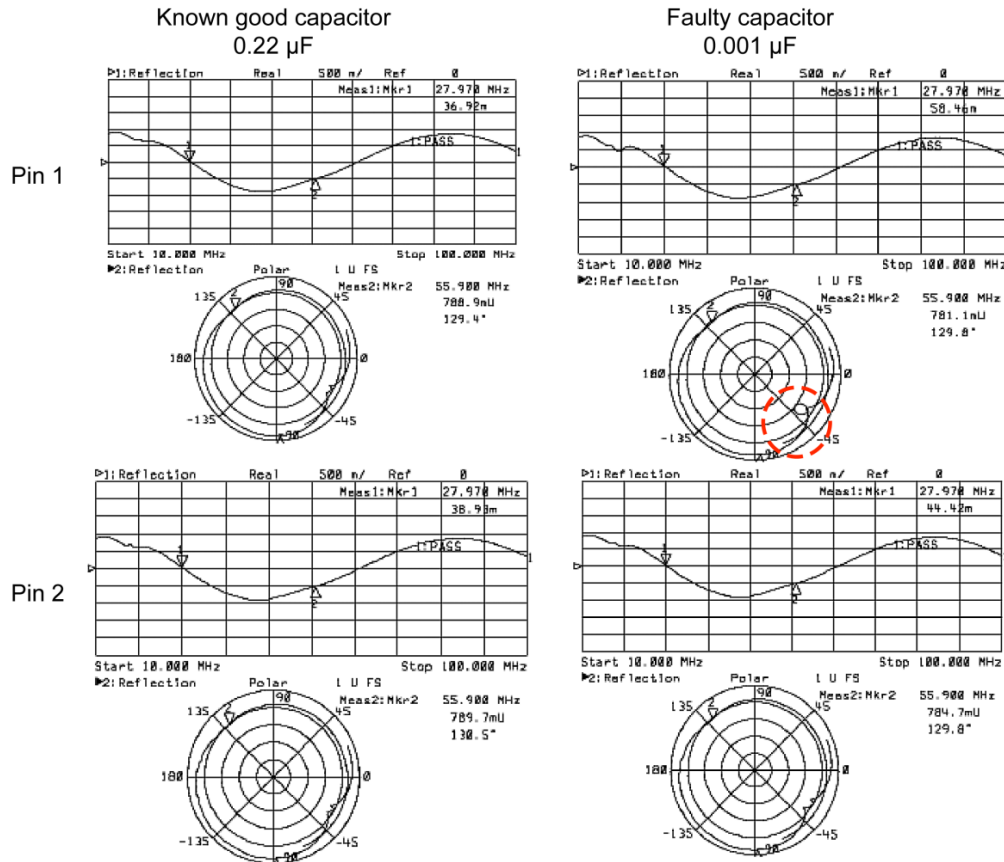

Figure 15.—Ceramic capacitor (C25) tested by Complex Signature Analysis (CSA) from 10 to 100 MHz on pins 1 and 2. For pin 1, there is a subtle difference (dashed circles) shown on the polar phase diagram. Large-value capacitors do not show significant difference. This is due to the frequency dependence of capacitance, where increasing frequency reduces impedance. At the operating frequency of the network analyzer (10 to 100 MHz), the capacitor is seen as short. For pin 2, which is connected to ground, the signal should not be significantly different.

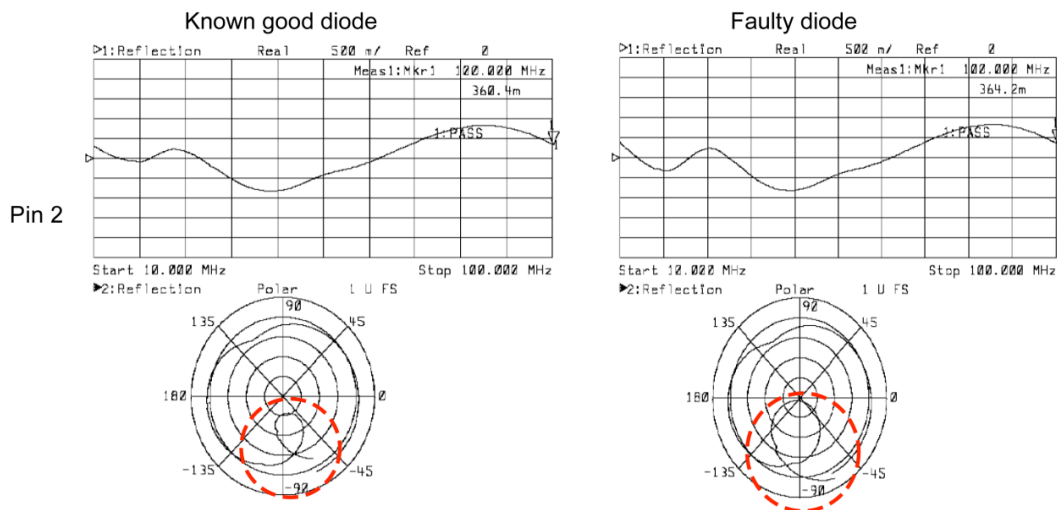

Figure 16.—Diode 1N914 (D4) tested by Complex Signature Analysis (CSA) on pin 2. Pin 1 of the diode was connected to a low-impedance power-supply side and, thus, would not respond to the frequency sweep. Differences are highlighted by the dashed circles.

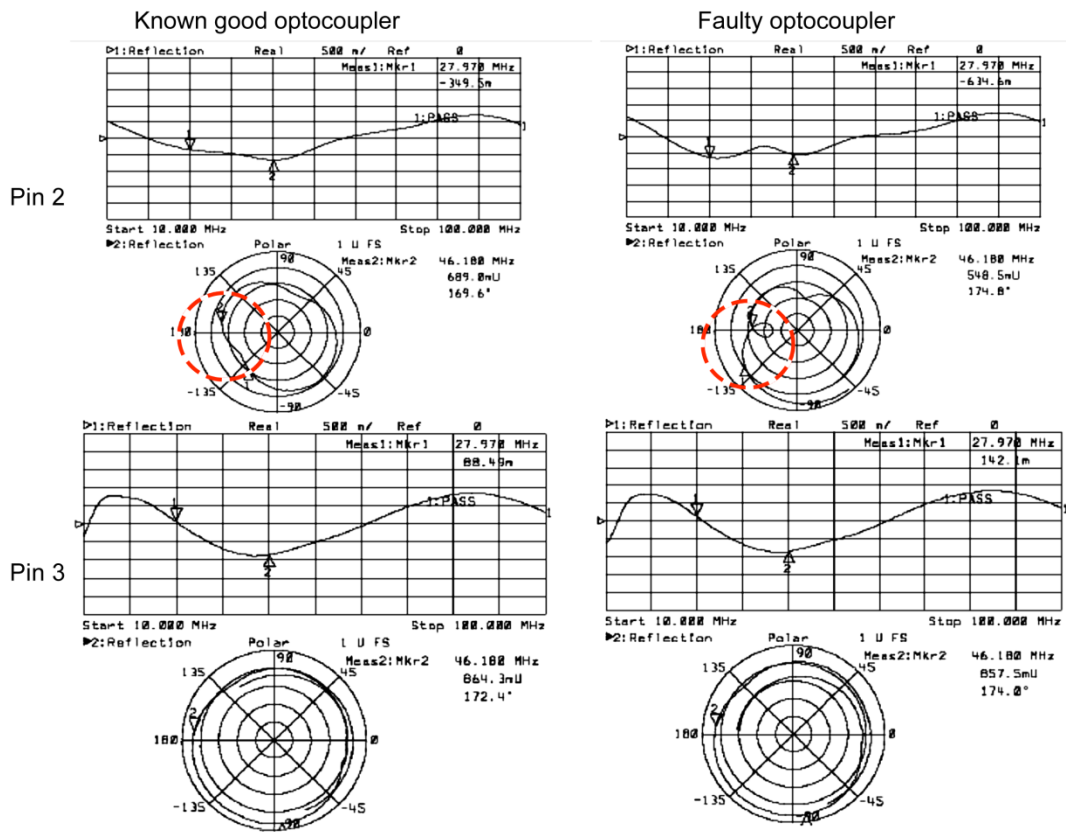

Figure 17.—Analog optocoupler 6N137 (U4) tested by Complex Signature Analysis (CSA) on pins 2 and 3 (diode connections). Note that it is easier to identify the fault in the polar plot. (See the dashed circles.)

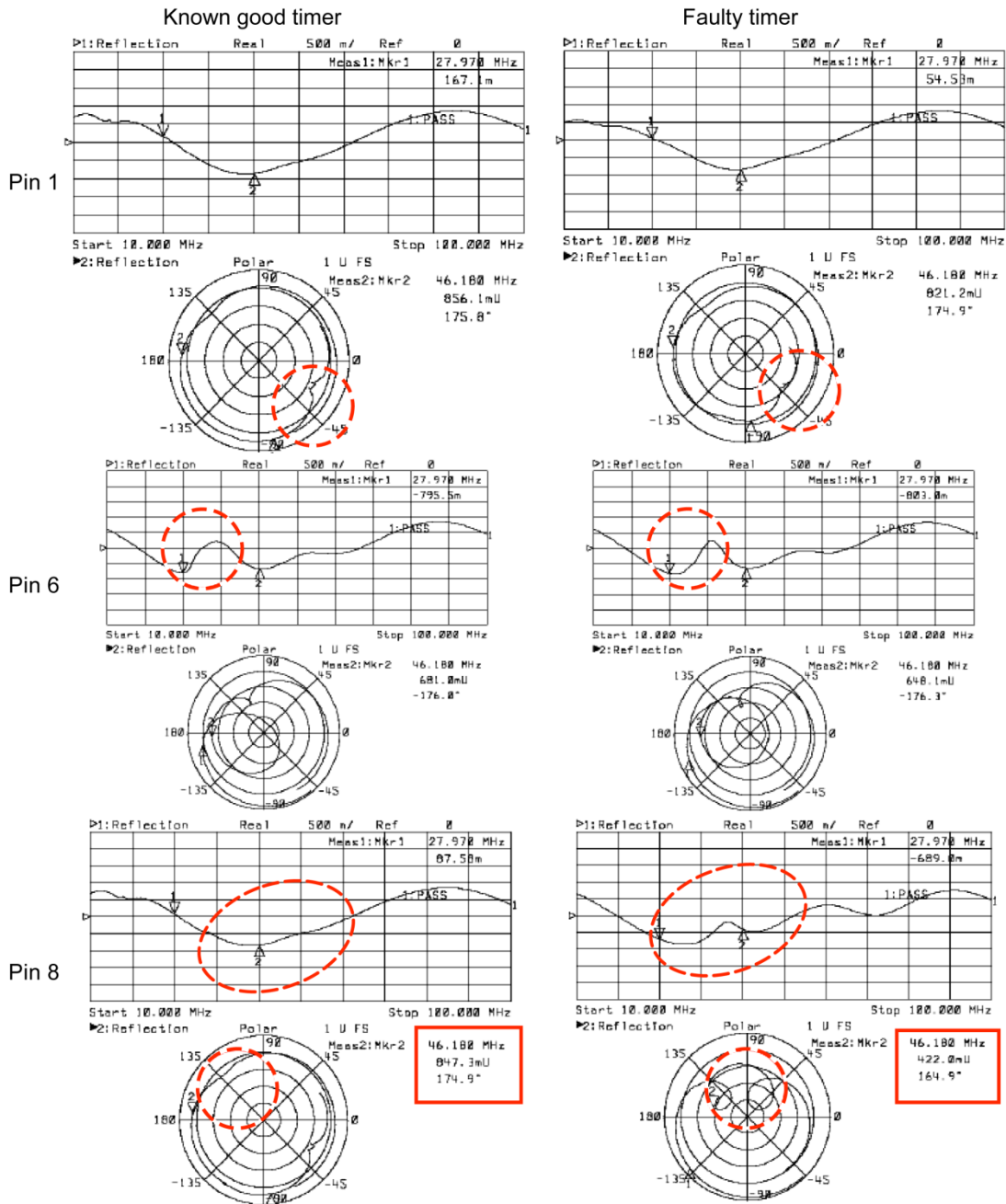

Figure 18.—Analog timer NE555 (U9) tested by Complex Signature Analysis (CSA) on pins 1, 6, and 8. CSA fault detection may be more subtle than ASA, and measurement markers on the polar plot for selected frequencies help phase shift because of reactance. Polar plots (and Smith Charts) can be more precise than simply comparing curve shapes. However, for pin 6 the simple linear plot was less ambiguous. (See the dashed circles.)

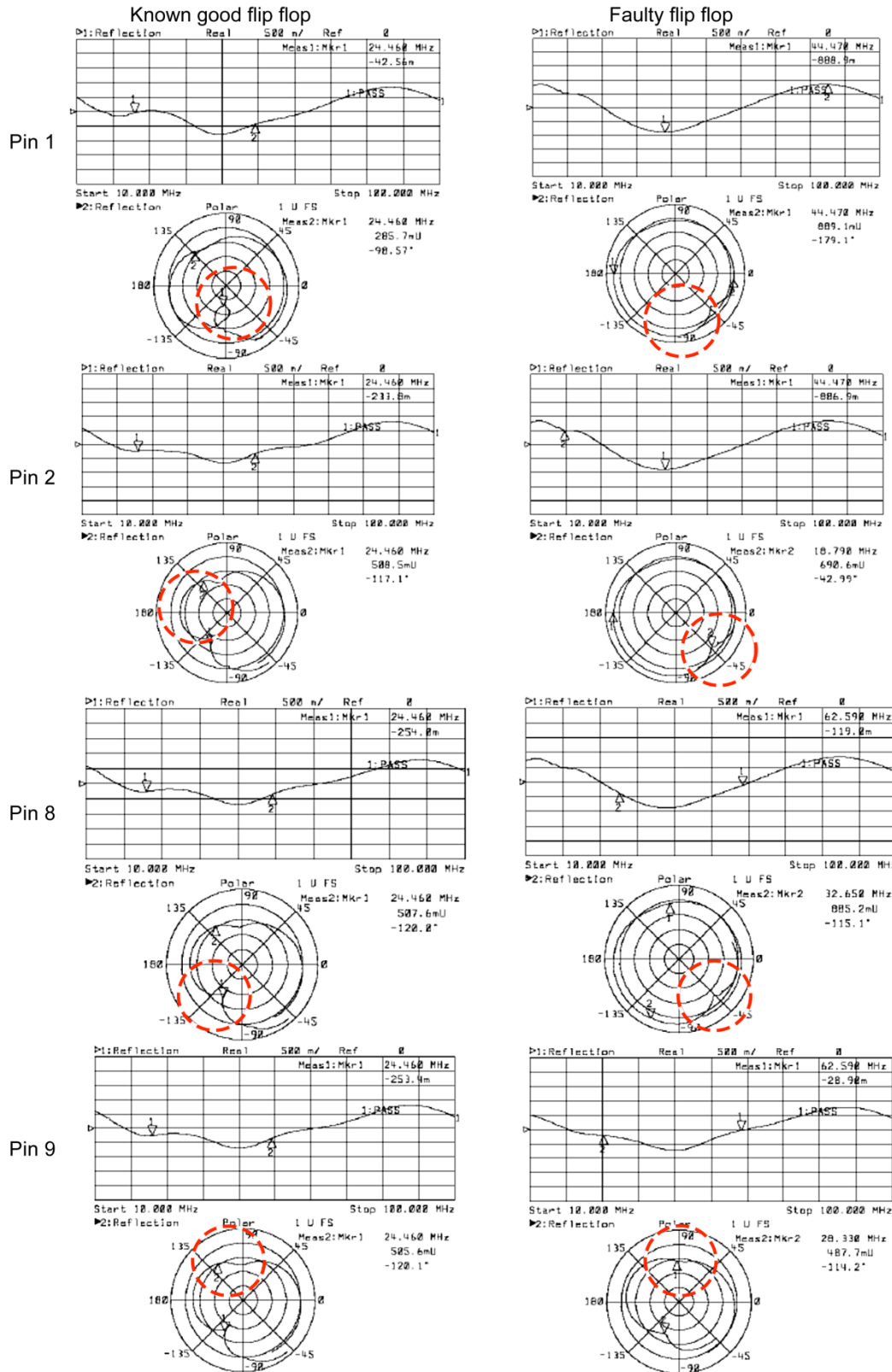

Figure 19.—Digital circuit 7473 flip flop (U8) tested by Complex Signature Analysis (CSA) on pins 1, 2, 8, and 9. CSA performed better than expected for digital applications, and once again, the polar plots with frequency markers are easier to use for fault detection than a linear plot. (See the dashed circles.)

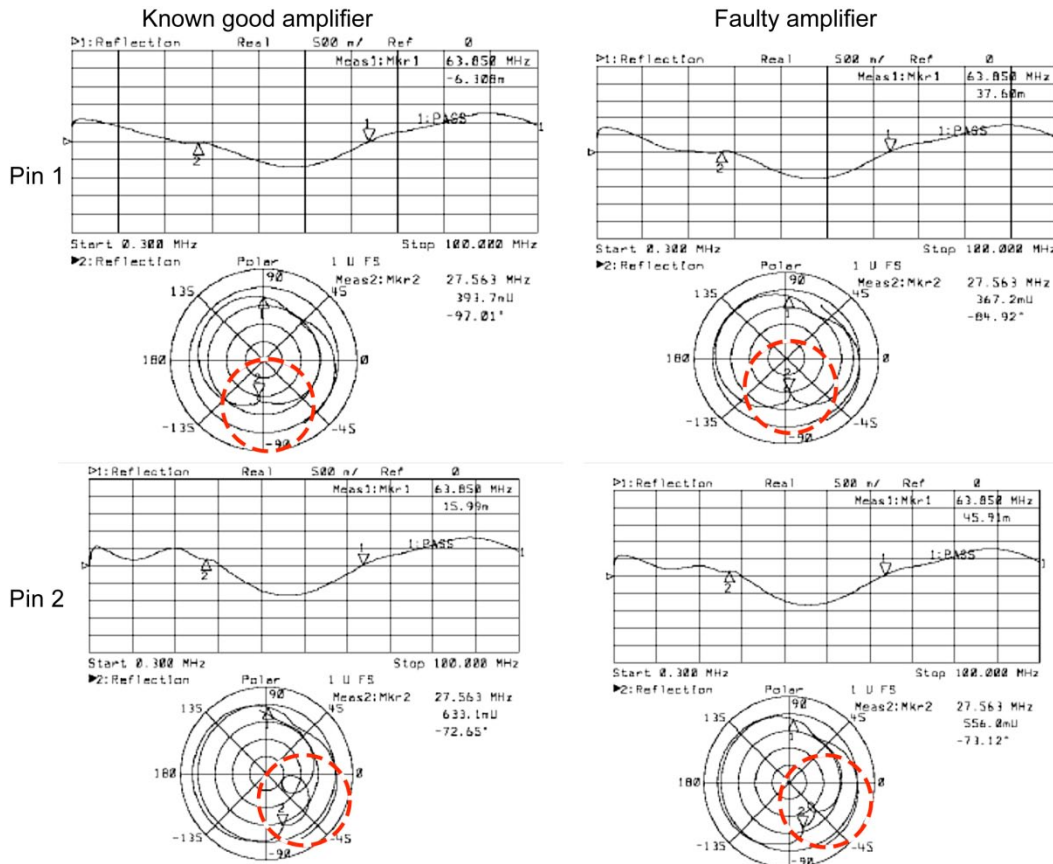

Figure 20.—Motorola CA282C 1-W wide-band linear radiofrequency (RF) amplifier tested by Complex Signature Analysis (CSA) on pins 1 and 2. Input stages do not show significant differences, but the difference is visible in the output stage. (See the dashed circles.)

8.3 Comparison Summary for Analog Signature Analysis and Complex Signature Analysis

Table III shows a modest overlap in the fault-detection capabilities of ASA and CSA. There are areas where the selection of either ASA or CSA is a clear choice. Generally, ASA is more effective in the low-frequency (or baseband) range, whereas CSA is more effective at high frequencies. There are techniques and features that can be used to extend the effective range of both techniques.

TABLE III.—APPLICATIONS OF ANALOG SIGNATURE ANALYSIS (ASA) AND COMPLEX SIGNATURE ANALYSIS (CSA)

	ASA Huntron analyzer	CSA Agilent network analyzer
Resistors	X	X
Large capacitors	X	
Small capacitors (<100 pF)		X
Large inductors	X	
Small inductors (<100 μH)		X
Active components	X	X
Radiofrequency circuits		X

9.0 Future Development

9.1 Instrument Development for Analog Signature Analysis and Complex Signature Analysis

The ASA unit was an unaltered commercially available model developed by Huntron and could be converted to a flight unit with limited repackaging and qualification tests. This particular model was “panelless”; that is, it did not provide external user control features or a display. The input and display functions were handled by a user computer.

For this study, CSA tests involved an unaltered commercially available Agilent 8712ET RF Network Analyzer that was designed for other applications. In addition, it was a conventional instrument with full-featured interface controls and a display panel. For space flight this instrument would need to be redesigned for CSA applications. Certain features would need to be tailored for CSA, and other network analyzer features would be eliminated. For CSA, software will need to be developed to streamline and automate the setup, control, and data management functions. Eliminating the front panel controls and data display could reduce the size of the CSA instrument dramatically.

The RF network analyzer could be tailored for CSA applications in two ways. The reference impedance is typically $50\ \Omega$, which is a standard used in RF systems. Variable impedance would expand the sensitivity to circuits to cover the wide impedance range of common non-RF electronics.

CSA tests revealed that frequencies above 100 MHz began creating RF field emissions from the circuit board traces. Aside from generating unwanted interference with other equipment, the field emissions interact with lead wires, conductive hardware, and even the user’s hands in the vicinity of the circuit. These interactions alter the impedance properties of the test circuit and in effect invalidate the known good circuit data. This leads to false errors, ambiguous results, and misdiagnosis. Therefore, the frequency range of a RF network analyzer used as a CSA instrument will be limited to less than 100 MHz. Furthermore, the low-frequency limit of the RF network analyzer was 300 kHz, which is too high to effectively analyze low-frequency circuits. The lower frequency limit of a CSA unit should extend down to 10 kHz or less.

Both ASA and CSA are candidates for development as synthetic instruments. Synthetic instruments exploit software and the flexibility and performance of field-programmable gate array (FPGA) technology. ASA can be reproduced easily as a synthetic instrument. CSA, however, will require a special RF front end.

9.2 Noncontact Diagnostic

A preliminary feasibility study of the noncontact technique was conducted, and the results are reported separately in CLEAR–ANA–002, Component-Level Electronic-Assembly Repair (CLEAR) Noncontact Coupling Techniques for Performing Signature Analysis. This technique is intended to address the problems of node access in circuits that are protected by conformal coatings. Both ASA and CSA operate by injecting AC signals into the test circuit and examining the response. If a probe can be coupled by capacitive, inductive, or RF coupling, it may be feasible to inject signals without removing the conformal coating.

Conformal coatings can be difficult and time consuming to remove and often result in damage to the underlying circuit. Probing by penetrating through the conformal coating layer can also result in damage to both the coating and circuit. A noncontact method of coupling will reduce the risk of damage and will simplify the overall process.

10.0 Conclusions

Analog Signature Analysis (ASA) and Complex Signature Analysis (CSA) have similar approaches but measure distinctly different circuit behaviors. ASA operates in the time domain, whereas CSA operates in the frequency domain and displays values using complex variable mathematics.

ASA measures the response to a small voltage input like a component tester, whereas CSA measures complex impedance, which is a multicomponent value that can be analyzed in different ways.

- Both ASA and CSA can be used in a signature comparison mode where the test signal is compared with a known good reference.
- Both ASA and CSA can be applied to an unpowered test circuit.
- Both ASA and CSA have frequency limitations but at opposite ends. ASA works in the low-frequency range (20 Hz to 5 kHz), whereas CSA works best at high frequencies (100 kHz and up).
- ASA does not perform well with RF circuits where high-frequency coupling methods are used. For example, RF circuits with transmission line transformers look like short circuits to ASA.
- CSA, in the tested configuration, does not perform well with large components or with low-frequency circuits that may include large capacitor or inductor elements.

The techniques have little overlap in their range, thus one technique does not encompass the capability of the other technique. Therefore, ASA and CSA diagnostics are considered to be complementary techniques. Further refinement of both ASA and CSA should provide users with a good initial fault-finding capability that is easy to use.

Appendix.—Acronyms and Abbreviations

AC	alternating current
ASA	analog signature analysis
CLEAR	Component-Level Electronic-Assembly Repair
CSA	complex signature analysis
DC	direct current
FPGA	field-programmable gate array
IC	integrated circuit
ISS	International Space Station
LC	inductor/capacitor
ORU	orbital replaceable unit
<i>V-I</i>	voltage-current

References

1. Huntron Diagnostic Systems Product Literature, 31-0087, Rev. D, Huntron Inc., 2005.
<http://www.huntron.com/products/diagnostics.htm> Accessed Jan. 27, 2009
2. User's Guide—HP 8712ET and HP 8714ET RF Network Analyzers. HP Part No. 08714-90011, Hewlett-Packard Co., Oct. 1999.

REPORT DOCUMENTATION PAGE			Form Approved OMB No. 0704-0188		
<p>The public reporting burden for this collection of information is estimated to average 1 hour per response, including the time for reviewing instructions, searching existing data sources, gathering and maintaining the data needed, and completing and reviewing the collection of information. Send comments regarding this burden estimate or any other aspect of this collection of information, including suggestions for reducing this burden, to Department of Defense, Washington Headquarters Services, Directorate for Information Operations and Reports (0704-0188), 1215 Jefferson Davis Highway, Suite 1204, Arlington, VA 22202-4302. Respondents should be aware that notwithstanding any other provision of law, no person shall be subject to any penalty for failing to comply with a collection of information if it does not display a currently valid OMB control number.</p> <p>PLEASE DO NOT RETURN YOUR FORM TO THE ABOVE ADDRESS.</p>					
1. REPORT DATE (DD-MM-YYYY) 01-01-2011		2. REPORT TYPE Technical Memorandum		3. DATES COVERED (From - To)	
4. TITLE AND SUBTITLE Component-Level Electronic-Assembly Repair (CLEAR) Spacecraft Circuit Diagnostics by Analog and Complex Signature Analysis			5a. CONTRACT NUMBER		
			5b. GRANT NUMBER		
			5c. PROGRAM ELEMENT NUMBER		
6. AUTHOR(S) Oeftering, Richard, C.; Wade, Raymond, P.; Izadnegahdar, Alain			5d. PROJECT NUMBER		
			5e. TASK NUMBER		
			5f. WORK UNIT NUMBER WBS 825855.01.03.03.03		
7. PERFORMING ORGANIZATION NAME(S) AND ADDRESS(ES) National Aeronautics and Space Administration John H. Glenn Research Center at Lewis Field Cleveland, Ohio 44135-3191			8. PERFORMING ORGANIZATION REPORT NUMBER E-17557		
9. SPONSORING/MONITORING AGENCY NAME(S) AND ADDRESS(ES) National Aeronautics and Space Administration Washington, DC 20546-0001			10. SPONSORING/MONITOR'S ACRONYM(S) NASA		
			11. SPONSORING/MONITORING REPORT NUMBER NASA/TM-2011-216952		
12. DISTRIBUTION/AVAILABILITY STATEMENT Unclassified-Unlimited Subject Category: 33 Available electronically at http://gltrs.grc.nasa.gov This publication is available from the NASA Center for AeroSpace Information, 443-757-5802					
13. SUPPLEMENTARY NOTES					
14. ABSTRACT The Component-Level Electronic-Assembly Repair (CLEAR) project at the NASA Glenn Research Center is aimed at developing technologies that will enable space-flight crews to perform in situ component-level repair of electronics on Moon and Mars outposts, where there is no existing infrastructure for logistics spares. These technologies must provide effective repair capabilities yet meet the payload and operational constraints of space facilities. Effective repair depends on a diagnostic capability that is versatile but easy to use by crew members that have limited training in electronics. CLEAR studied two techniques that involve extensive precharacterization of "known good" circuits to produce graphical signatures that provide an easy-to-use comparison method to quickly identify faulty components. Analog Signature Analysis (ASA) allows relatively rapid diagnostics of complex electronics by technicians with limited experience. Because of frequency limits and the growing dependence on broadband technologies, ASA must be augmented with other capabilities. To meet this challenge while preserving ease of use, CLEAR proposed an alternative called Complex Signature Analysis (CSA). Tests of ASA and CSA were used to compare capabilities and to determine if the techniques provided an overlapping or complementary capability. The results showed that the methods are complementary.					
15. SUBJECT TERMS Space operations; Space logistics					
16. SECURITY CLASSIFICATION OF:			17. LIMITATION OF ABSTRACT UU	18. NUMBER OF PAGES 36	19a. NAME OF RESPONSIBLE PERSON STI Help Desk (email:help@sti.nasa.gov)
a. REPORT U	b. ABSTRACT U	c. THIS PAGE U			19b. TELEPHONE NUMBER (include area code) 443-757-5802

